

SAMSUNG

Climate Solutions

**Product
Catalogue**
Eco Heating Systems



20/21

Highlights for 2020-2021

WindFree™

Samsung extends its WindFree™ Technology with a completely new WindFree™ wall-mounted model for its EHS TDM Plus product range. The latest TDM Plus WindFree™ Deluxe is equipped with WindFree™ Cooling technology, spreading fresh air gently and evenly through thousands of micro-holes to create "Still Air" conditions¹.



TDM Plus WindFree™ Deluxe



WindFree™
Cooling

Wi-Fi Control
(optional)

Fast Cooling

- Equipped with NASA communication protocol.
- Available in capacity range 2.2-5.6 kW with optional EEV kit.

Wi-Fi Control

The new optional Wi-Fi Kit allows users to control up to 16 connectable indoor units via smartphone with the Samsung SmartThings app². The app checks indoor temperature, outdoor temperature and air quality levels, and then recommends the optimal operating mode. It also offers the option of adding user scenes such as working, walking or resting. The geofencing functionality allows the room temperature to be automatically set at the desired level when the user approaches within a preset distance of 100 m - 150 km from the building.



Wi-Fi Kit

- Wi-Fi control up to 16 indoor units through Samsung SmartThings.
- Welcome Cooling or Heating through geofencing functionality.
- Individual energy monitoring for up to 16 outdoor units.
- The voice command feature is available through a smartphone with Bixby³.



¹ ASHRAE (the American Society of Heating, Refrigeration, and Air-Conditioning Engineers) defines "Still Air" as air currents moving at speeds below 0.15 m/s, with no cold drafts.

² A Wi-Fi connection and Samsung SmartThings application account are required. Wi-Fi Kit to be ordered separately. Requires iOS 10.0 or later & Android 5.0 or later.

³ Currently Voice control is supported in English (US, UK, Indian), Chinese, Korean, French, German, Italian, Spanish and Portuguese.

ClimateHub TDM Plus

The Samsung EHS (Eco Heating System) extends the compact and modular Tank Integrated Hydro Unit for TDM Plus in addition to Mono and Split. The ClimateHub with Tank Integrated Hydro Unit saves space, but also reduces the time of installation. With a 2-zone control and advanced functions, energy efficiency and sustainability performance are optimised. Its Time Division Multi Operation means it can supply hot water while also cooling spaces.



ClimateHub TDM Plus



Floor heating



Radiator



Hot water



Quiet operation



Smooth installation



Wi-Fi Control (optional)

- Compact unit size with large water tank (200 L and 260 L).
- Intuitive, colour screen touch controller in multiple languages¹.
- Energy monitoring through touch controller.
- 2-zone control, suitable for floor heating and radiators.
- SmartThings compatible with optional Wi-Fi kit².
- Backup heater is included to ensure continuous heating.
- Solar Power (PV) and Smart Grid ready.
- Smooth servicing through the front-mounted service window.

¹Available languages: English, German, Spanish, French, Italian and Polish. ²A Wi-Fi connection and Samsung SmartThings application account are required. Wi-Fi Kit to be ordered separately. Requires iOS 10.0 or later & Android 5.0 or later.

Product overview

Mono

The EHS Mono can connect to third party equipment such as a Domestic Hot Water (DHW) tank thanks to the Samsung Mono control kit. The Mono Control kit includes a controller, flow sensor, DHW sensor and leaving and return water sensors.

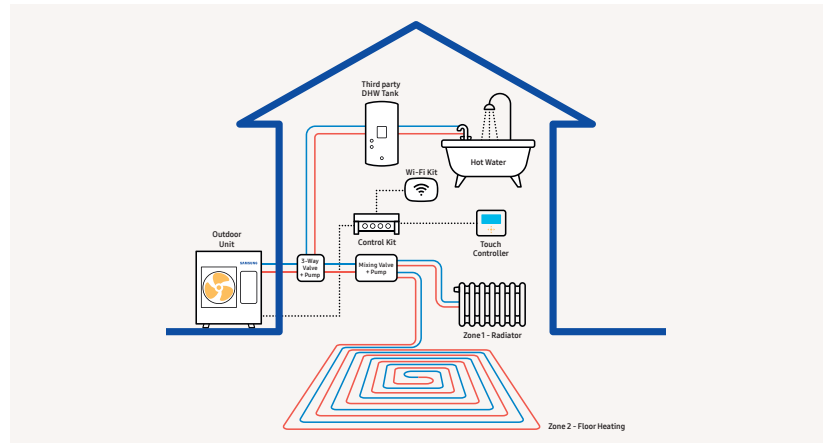

Split

The EHS Split outdoor unit is connected to a wall-mounted Hydro Unit to combine with a third party Domestic Hot Water (DHW) tank to suit all requirements. When used with the Hydro Unit, the Split enables production of domestic hot water and underfloor heating/cooling, and heating of radiators.

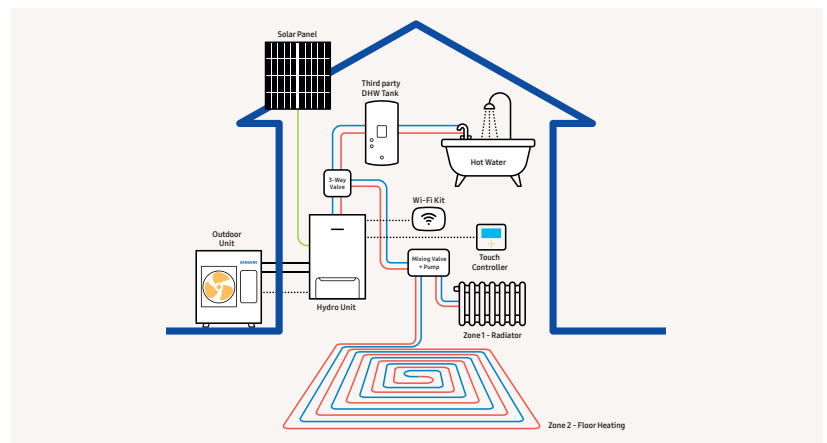





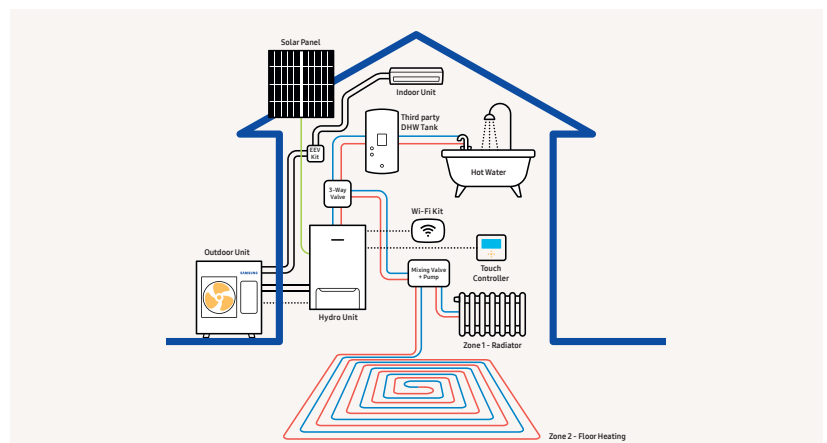

















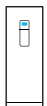

TDM Plus



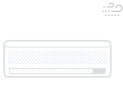







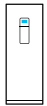

The EHS TDM Plus outdoor unit can connect to a third party Domestic Hot Water Tank (DHW) via a wall-mounted Hydro Unit. TDM Plus with a third party connection offers A2W and A2A home climate comfort.

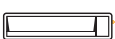

Schematic drawings are for illustrative purposes only. For accurate installation information please consult the technical data book. The selection of the exact product is subject to specific application conditions. Solar panels, underfloor heating panels, radiators and non-integrated components are not provided by Samsung unless specified otherwise. For more detailed product information and technical specifications, please consult the respective product pages of this Product Catalogue.

Indoor Units			Available Samsung product range			Controls		
								
Tank Integrated Hydro Unit	Wall-Mounted Hydro Unit	Third party DHW Tank	R32	Wireless	Wired	Centralised		
								
Wall-Mounted	Duct	Console	R410A	Mono Control Kit	Wi-Fi Kit			

Indoor Units			Available Samsung product range			Controls		
								
Tank Integrated Hydro Unit	Wall-Mounted Hydro Unit	Third party DHW Tank	R32	Wireless	Wired	Centralised		
								
Wall-Mounted	Duct	Console	R410A	Mono Control Kit	Wi-Fi Kit			

Indoor Units			Available Samsung product range			Controls		
								
Tank Integrated Hydro Unit	Wall-Mounted Hydro Unit	Third party DHW Tank	R32	Wireless	Wired	Centralised		
								
Wall-Mounted	Duct	Console	R410A	Mono Control Kit	Wi-Fi Kit			

Product overview

ClimateHub Mono

The ClimateHub Mono configuration has a single outdoor unit that includes the hydronic system, making it easy to install and use. The system's potential can be maximised by connecting to Smart Grid or Solar Power (PV).

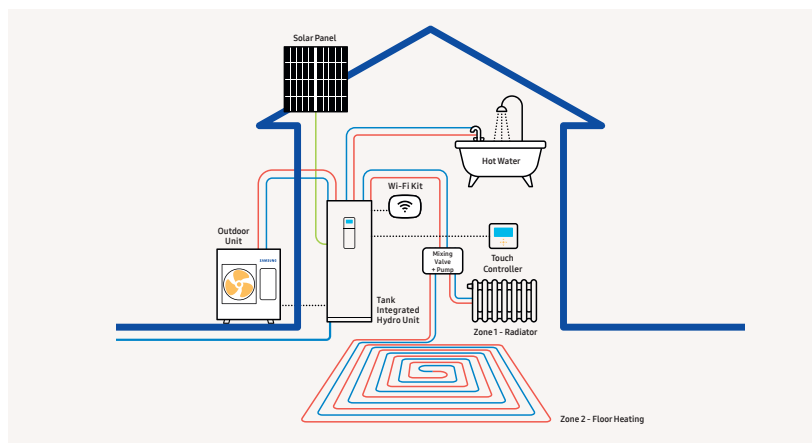

ClimateHub Split

The ClimateHub Split configuration has a single outdoor unit, connected by refrigerant pipes to the tank integrated hydro unit. To maximise its potential, the system can be connected to Smart Grid or Solar Power (PV).

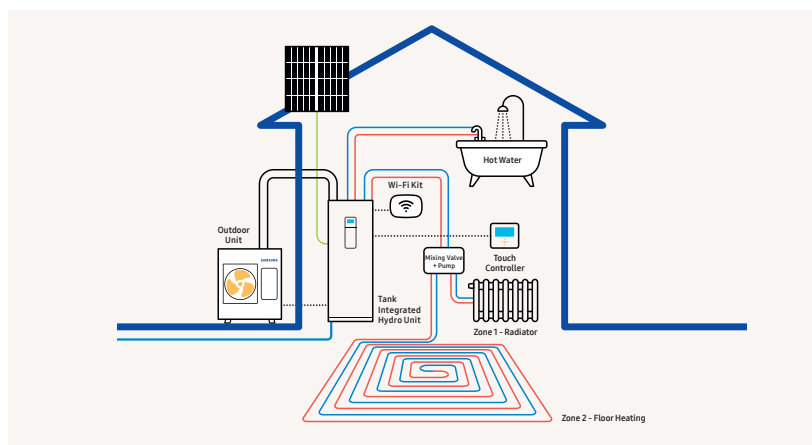

ClimateHub TDM Plus NEW

The TDM Plus system is an 'All-In-One' Air-to-Water (A2W) and Air-to-Air (A2A) system for a complete home climate solution. It can be used throughout the year for cooling and heating to meet a variety of different user situations and needs. It enables underfloor heating/cooling and radiator heating, as well as offering A2A cooling with various options for air conditioning. The system's potential can be maximised by connecting to Smart Grid or Solar Power (PV).

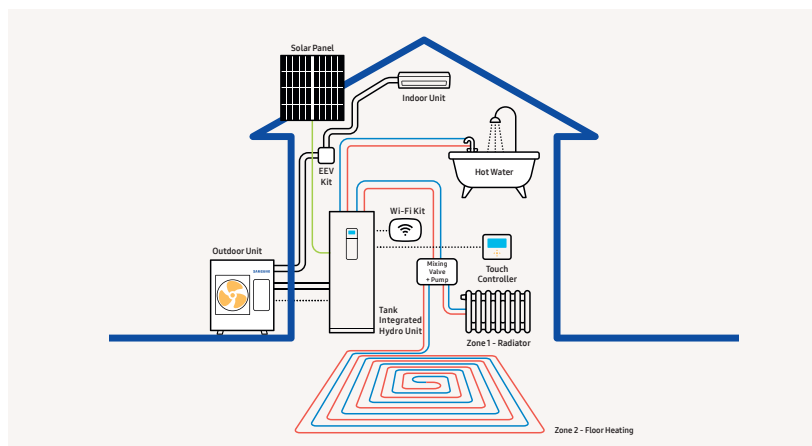

Schematic drawings are for illustrative purposes only. For accurate installation information please consult the technical data book. The selection of the exact product is subject to specific application conditions. Solar panels, underfloor heating panels, radiators and non-integrated components are not provided by Samsung unless specified otherwise. For more detailed product information and technical specifications, please consult the respective product pages of this Product Catalogue.





Project: Casa L (Spain)
Project Architecture: ABATON
Interior Design: BATAVIA
Photography: Carlos Muntadas

Table of contents

Introduction

Samsung Climate Solutions at a glance
Reference projects in the spotlight
Regulations and Standards
Certifications **NEW**

Eco Heating Systems (EHS)

Product Line-up
Selecting the right heating system
Nomenclature
ClimateHub Features

Mono

ClimateHub Mono
Mono with Third Party DHW Tank

Split

ClimateHub Split
Split with Third Party DHW Tank

TDM Plus

ClimateHub TDM Plus **NEW**
TDM Plus with Third Party DHW Tank
TDM Plus WindFree™ Deluxe **NEW**
TDM Plus Slim Duct
TDM Plus MSP Duct
TDM Plus Console

Controls

Line-up
Features

Accessories

Line-up

Design and support

Samsung Climate Solutions Partner Portal
DVM Pro 2.0 **NEW**
Samsung Climate Solutions Academy
Hydraulic Schematics **NEW**

Samsung Climate Solutions at a glance

The solutions that we offer



Cooling



Heating



Hot water



Ventilation

At Samsung, we focus on providing cutting-edge innovations in indoor climate comfort and being a leader in intelligent digital connectivity solutions.

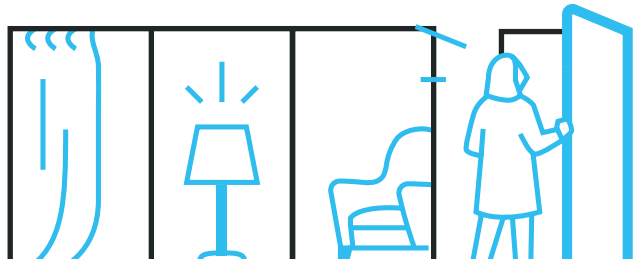

Our market-centric product ranges

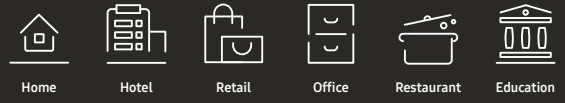

Residential	RAC FJM	
Light Commercial	CAC FJM	CAC
Commercial		DVM HVM ERV
Heating	EHS	
Controls	CONTROLS	



Services we provide to empower our partners

Corporate and Technology milestones that make us proud

1974

Samsung introduces its first air conditioner.

2005

Samsung Electronics enters the European market for commercial air conditioning.

2017

Samsung Electronics opens Samsung Electronics Air Conditioner Europe B.V. (SEACE) in Amsterdam.

2014

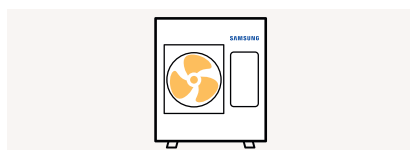

Arrival of the Samsung TDM concept, an all-in-one heat pump solution for heating, cooling and domestic hot water supply.

2015



Introduction of the Samsung 360 Cassette, the world's first circular air conditioner that fits seamlessly into the design of any space.

2017

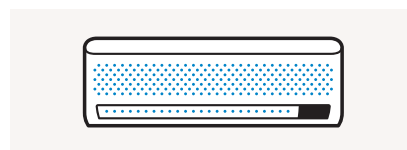

Samsung WindFree™ technology comes onto the market, gently and evenly dispersing fresh air through thousands of micro-holes to limit cold drafts.

WindFree™



WindFree™ Cooling

SmartThings



Wi-Fi Control

b.IoT



Building Management System

Our flagship innovations that enrich people's lives

Our European footprint with the locations from which we operate

● 1 | Samsung Electronics Air Conditioner Europe B.V.
● 16 | Samsung offices ● 8 | Warehouses ● 9 | Training centres

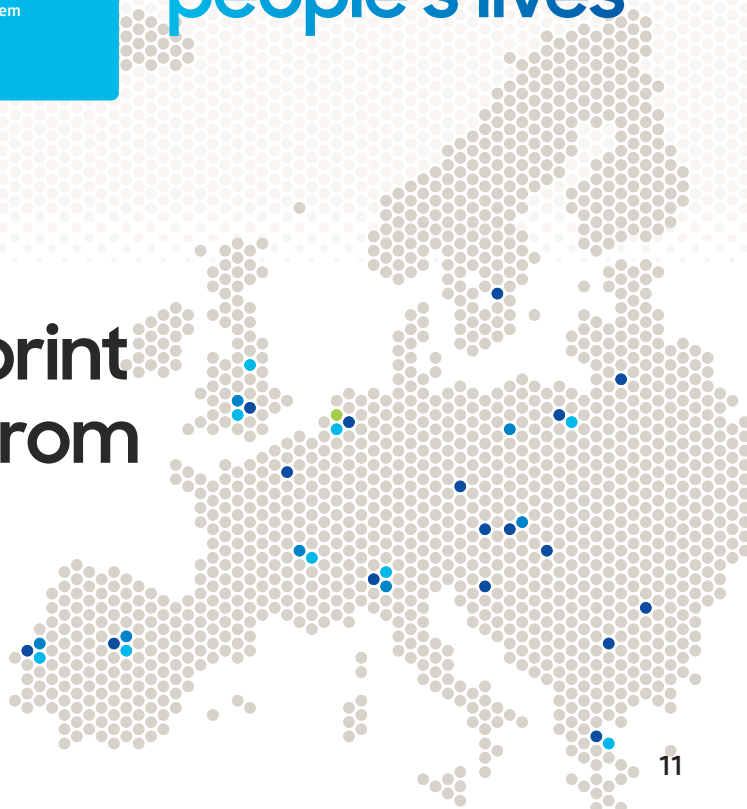

Samsung reference projects in the spotlight

Project Etopia





Joseph Daniels

CEO
Project Etopia Group

“A big step in our Samsung partnership is working collaboratively on the heat pump technology. Through this partnership we are able to provide not only heating, cooling and hot water, but we can do this all whilst utilising renewable energy sources. Our class leading pilot project at the BRE innovation park in Watford, UK, uses this system and has been engineered to be more than energy positive. The real game changer for this product specifically is the ability to intelligently control and harmonise it with our smart home system, providing unseen thermal, energy and environmental control with a positive impact on both cost savings and lifestyle.”

Application



Residential

Samsung products installed



TDM Plus
Outdoor Unit

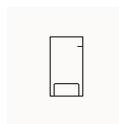

Wall-Mounted
Hydro Unit



SmartThings

Regulations and standards

Samsung strives to provide customers with new eco-friendly experiences and lead the way to a sustainable future for the global community through innovative and eco-friendly products and technology. We monitor applicable environmental standards and laws and regulations in the context of our climate solutions operations. Samsung also conducts environmental improvement activities across all product development, production, distribution, use and disposal phases.

Energy Label

Space heaters, combination heaters, packages of space heater, temperature control and solar device and packages of combination heater, temperature control and solar device are subject to Energy labelling EU Regulation No. 811/2013 and Ecodesign EU Regulation No. 813/2013 requirements.

As of September 2019, the energy efficiency scale for seasonal space heating ranges from A+++ to D, with A+++ being the most efficient. The water heating energy efficiency scale for the declared load profile for combination heat pumps ranges from A+ to F, with A+ being the most efficient.

The energy labels should provide minimum necessary information such as; supplier's name, product model code, the rated output under three European climates (average, colder and warmer) for medium- and/or low-temperature applications (55 °C and 35 °C), European map displaying the three temperature zones, the sound power level indoors and/or outdoors. In addition, just for combination heat pumps, the energy label should also include a pictogram showing to be able to work only during off-peak hours.

Energy Label

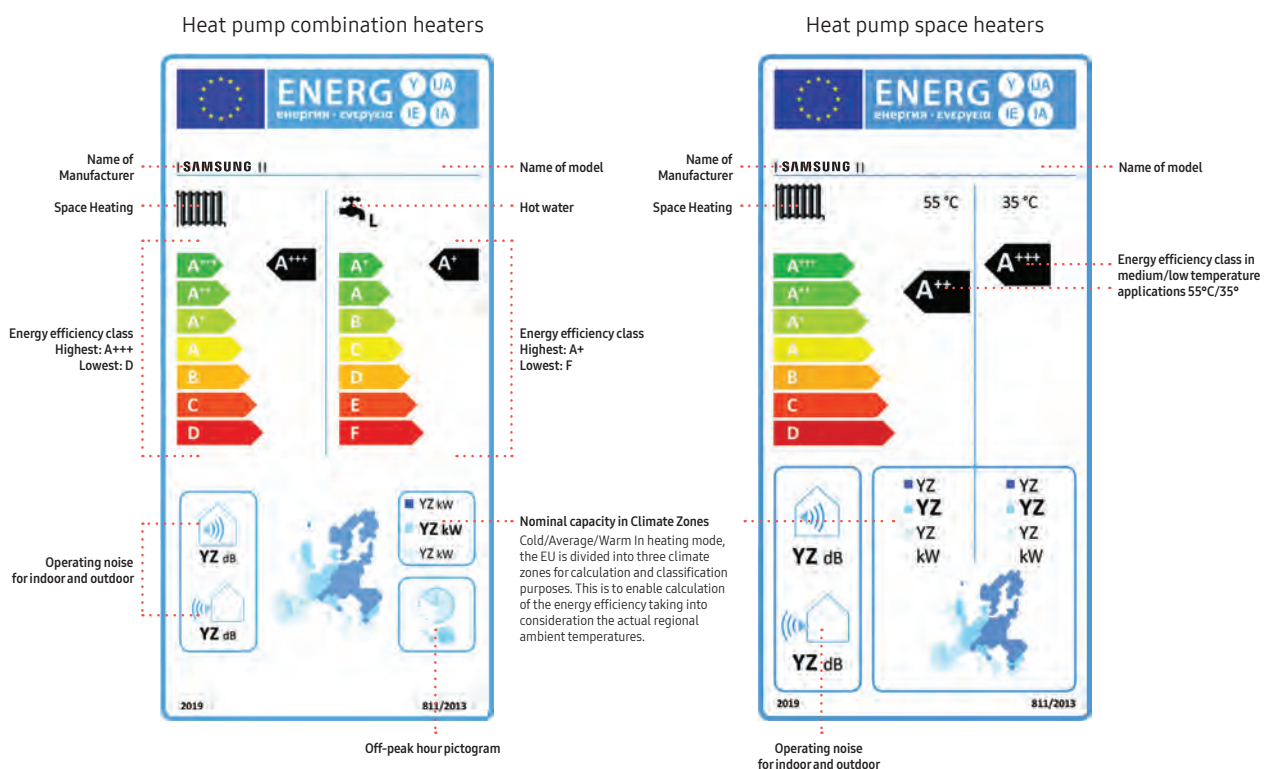

F-Gas regulation

The EU aims to reduce the environmental impact of F-gases through the reduction of the CO₂ equivalent consumption of HFCs (hydrofluorocarbons). EU regulation 517/2014 prescribes a phase-down of HFCs, where the quantities of HFCs that are placed on the market are gradually reduced through the allocation of quotas by the European Commission. The phase-down targets are expressed in CO₂ equivalents (= kg x GWP - Global Warming Potential) and aim to reduce HFC

consumption by 79 % in 2030. For new installations of single split air conditioners with a refrigerant charge below 3 kg, the GWP limit is set at 750 starting in 2025. The regulation has been put into force to encourage the industry and its users to transition to refrigerants with a lower GWP. Samsung is accelerating the transition towards lower GWP refrigerants, such as R32, and will continue to invest in environmentally friendly alternatives.

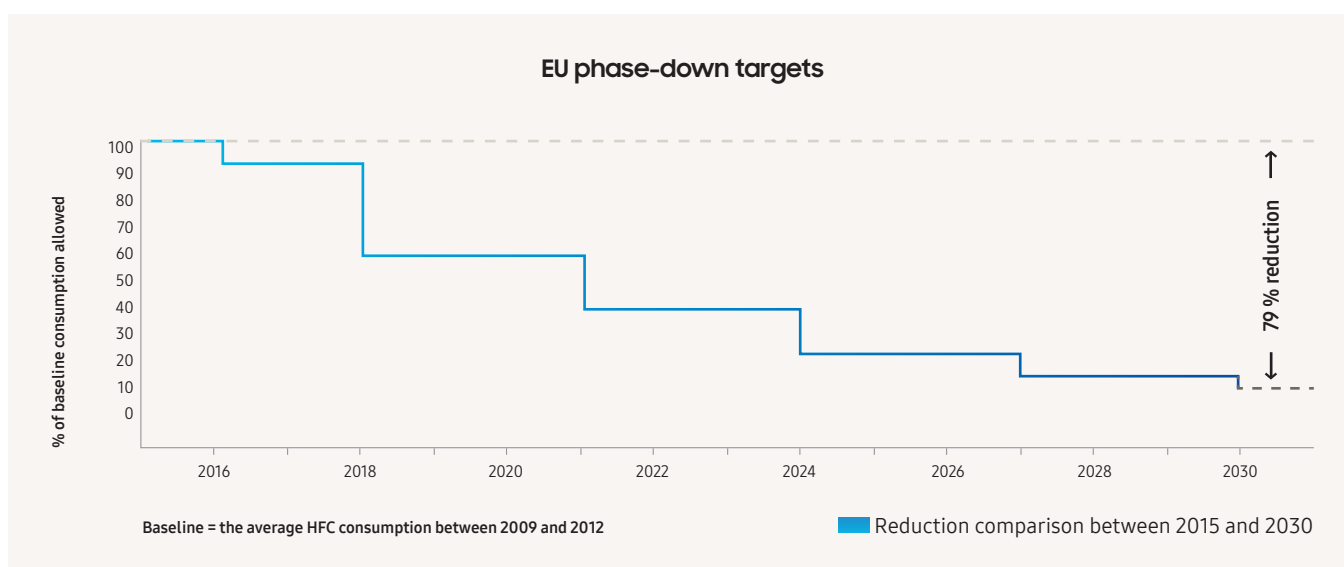

R32 Refrigerant

R32 refrigerant contributes to meeting the F-gas regulation targets as described in EU regulation 517/2014. Air conditioners with R32 refrigerant have a Global Warming Potential (GWP) of 675, which is significantly lower than the GWP of R410A (2,088). While refrigerants are an essential part of today's air conditioners, R32 would have a 68 % lower environmental impact¹ than R410A if leaked into the atmosphere. It has an Ozone Depletion Potential (ODP) of zero, a high refrigeration capacity and a high thermal conductivity; meaning a high efficiency and a reduction in charging volume. Samsung's single split Residential (RAC), Multi Split (FJM) and Commercial (CAC) product ranges up to 12 kW all feature R32 refrigerant.

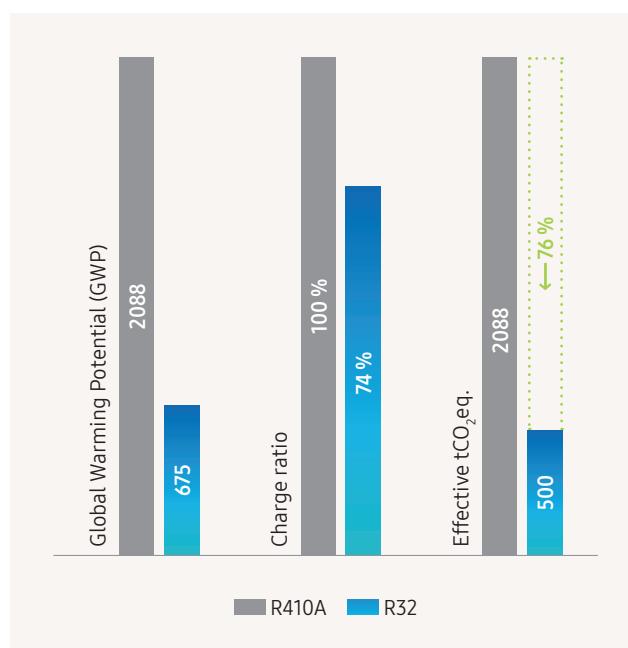

¹ Comparison between R410A and R32 GWP. Source: European Commission.



WEEE: Electronic Waste

Samsung adheres to the WEEE (Waste Electrical and Electronic Equipment) Directive. This Directive applies the principles of extended producer responsibility. It stipulates the safe collection, treatment, recycling and environmentally sound disposal of all electrical and electronic equipment. By working with collective recycling schemes in each EU member state Samsung co-finances the take-back and recycling of electronic products.

Batteries

Samsung has been giving new life to used batteries by funding collection, treatment and recycling by local battery recycling organisations.

Packaging

Samsung works together with recycling schemes and governmental organisations to collect, separate and reuse all packaging materials at various points in the distribution chain. Many materials can be recycled into new products and recycling helps to save natural resources. Recycling packaging helps to reuse valuable raw materials and to reduce the overall impact on the environment.





Certifications

Heat Pump KEYMARK Certificate

The Heat Pump KEYMARK is a voluntary, independent, European certification mark (ISO type 5 certification) for all heat pumps, combination heat pumps and hot water heaters (as covered by Ecodesign, EU Regulation 813/2013 and 814/2013). It is based on independent, third-party testing and demonstrates compliance with product requirements as set in the Heat Pump KEYMARK scheme rules and with efficiency requirements as set by Ecodesign. It is aimed at certifying the product performances declared by the manufacturers.

The Heat Pump KEYMARK scheme is owned by the European Committee for standardization (CEN). The certificates are granted by independent certification bodies to products fulfilling all requirements of the scheme.

Samsung's Eco Heating Systems and the ClimateHub range are certified with a Heat Pump KEYMARK. This certification is recognised in a number of European countries which include France, Germany, the United Kingdom, Slovakia and Czech Republic.



Eurovent Certificate

Eurovent is globally known for its quality mark 'Eurovent Certified Performance' which certifies performance ratings of air-conditioning and refrigeration products according to European and international standards. The 'Eurovent Certified Performance' mark indicates that the prescribed quality requirement has been fulfilled and should not require the need to be proven after the customer's decision and after the manufacturer's production process.

Eurovent is an accredited third-party certification body. It builds customer confidence by leveling the competitive playing field for all manufacturers and by increasing the integrity and accuracy of the industrial performance ratings. Thus providing trustworthy services to the entire ecosystem.

Samsung air conditioning products ranging from the Residential Air-Conditioning (RAC), Multi Split (FJM), Commercial Air Conditioning (CAC), Digital Variable Multi S (DVM S) and Eco Heating System (EHS) line-up in the 'Air-to-Water' (A2W) heat pump category are all Eurovent certified.

To check the ongoing validity of the Eurovent certified products from Samsung, please visit: www.eurovent-certification.com



Product Line-up





Line-up

ClimateHub



Type	Power	Model Name	Capacity	Tank Integrated Hydro Unit (Split)			Tank Integrated Hydro Unit (Mono)			Tank Integrated Hydro Unit (TDM Plus)	
				200 L(1Φ) AE200RNWSEG/ EU	260 L(1Φ) AE260RNWSEG/ EU	260 L(3Φ) AE260RNWSGG/ EU	200 L(1Φ) AE200RNWMEG/ EU	260 L(1Φ) AE260RNWMEG/ EU	260 L(3Φ) AE260RNWGG/ EU	200 L(1Φ) AE200TNWTEH/ EU	260 L(1Φ) AE260TNWTEH/EU
R32 Outdoor Unit	Mono	1Φ	AE050RXYDEG/EU	5.0 kW				•			
			AE080RXYDEG/EU	8.0 kW				•	•		
			AE120RXYDEG/EU	12.0 kW				•	•		
		AE160RXYDEG/EU	16.0 kW				•	•			
		3Φ	AE080RXYDGG/EU	8.0 kW						•	
			AE120RXYDGG/EU	12.0 kW						•	
	AE160RXYDGG/EU		16.0 kW						•		
	Split	1Φ	AE040RXEDEG/EU	4.0 kW	•	•					
			AE060RXEDEG/EU	6.0 kW	•	•					
AE090RXEDEG/EU			9.0 kW	•	•						
	3Φ	AE090RXEDGG/EU	9.0 kW			•					
R410A Outdoor Unit	TDM Plus	1Φ	AE044MXTPEH/EU	4.4 kW						•	•
			AE066MXTPEH/EU	6.6 kW						•	•
			AE090MXTPEH/EU	9.0 kW						•	•
			AE120MXTPEH/EU	12.0 kW						•	•
			AE160MXTPEH/EU	16.0 kW						•	•
			3Φ	AE090MXTPGH/EU	9.0 kW						•
		AE120MXTPGH/EU		12.0 kW						•	•
		AE160MXTPGH/EU		16.0 kW						•	•

TDM Plus Indoor



Type		WindFree™ Deluxe	Slim Duct	MSP Duct	Console
Capacity	2.2 kW	•	•		•
	2.8 kW	•	•		•
	3.6 kW	•	•		•
	5.6 kW	•	•		•
	7.1 kW	•		•	
	9.0 kW			•	

Optional Controller



Model	MIM-H04EN
Model name	Wi-Fi Kit 2.0
Maximum connectible Indoor Units	16
App	SmartThings
Voice recognition	Bixby
Welcome Cooling/Heating	Geofencing
Automation	Customised control with a variety of execution rules
Add scene	Easy control throughout customised user mode
Energy monitoring	Individual energy monitoring up to 16 outdoor units
Product dimensions (mm) W x H x D	185 x 130 x 29



Model	MWR-WW10*N
Model name	Touch Controller
Screen size/type	4.3" Color LCD display
Intuitive user interface	Dynamic navigation with simplified buttons
Operation	Heating / Cooling/ Auto / DHW
Functions	Smart Grid Ready / PV Ready / 2-zone Control / Energy consumption monitor / Energy saving
Smart connectivity	SmartThings via optional Wi-Fi Kit 2.0
Languages	
MWR-WW10N	English, German, French, Italian, Spanish, Polish (EN, DE, FR, IT, ES, PL)
MWR-WW10JN <small>NEW IN Q1'21</small>	English, Portuguese, Dutch, Greek, Czech, Slovak (EN, PT, NL, EL, CS, SK)
MWR-WW10KN <small>NEW IN Q2'21</small>	English, Finnish, Swedish, Norwegian, Danish, Lithuanian (EN, FI, SV, NO, DA, LT)
Product dimensions (mm) W x H x D	120x120x19

Line-up

EHS with Third Party DHW Tank

Mono with Third Party DHW Tank



Outdoor Unit



Mono Control Kit



DHW Tank
(third party)

Type	Power	Model Name	Capacity	Mono	
				MIM-E03CN	
R32 Outdoor Unit	1Φ	AE050RXYDEG/EU	5.0 kW		•
		AE080RXYDEG/EU	8.0 kW		•
		AE120RXYDEG/EU	12.0 kW		•
		AE160RXYDEG/EU	16.0 kW		•
	3Φ	AE080RXYDGG/EU	8.0 kW		•
		AE120RXYDGG/EU	12.0 kW		•
		AE160RXYDGG/EU	16.0 kW		•

Split with Third Party DHW Tank



Outdoor Unit



Wall-Mounted
Hydro Unit



DHW Tank
(third party)

Type	Power	Model Name	Capacity	Wall-Mounted Hydro Unit	
				Split(1Φ) AE090RNYDEG/EU	Split(3Φ) AE090RNYDGG/EU
R32 Outdoor Unit	1Φ	AE040RXEDEG/EU	4.0 kW	•	
		AE060RXEDEG/EU	6.0 kW	•	
		AE090RXEDEG/EU	9.0 kW	•	
	3Φ	AE090RXEDGG/EU	9.0 kW	•	•
R410A Outdoor Unit	1Φ	AE120JXEDEH/EU	12.0 kW	•	
		AE160JXEDEH/EU	16.0 kW	•	
	3Φ	AE120JXEDGH/EU	12.0 kW		•
		AE160JXEDGH/EU	16.0 kW		•

TDM Plus with Third Party DHW Tank

TDM Plus with Third Party DHW Tank



Outdoor Unit



Wall-Mounted
Hydro Unit



DHW Tank
(third party)

Type	Power	Model Name	Capacity	Wall-Mounted Hydro Unit			
				Split(1Φ)		Split(3Φ)	
				AE090MNYDEH/EU	AE160MNYDEH/EU	AE090MNYDGH/EU	AE160MNYDGH/EU
R410A TDM Plus Outdoor Unit	1Φ	AE044MXTPEH/EU	4.4 kW	•			
		AE066MXTPEH/EU	6.6 kW	•			
		AE090MXTPEH/EU	9.0 kW	•			
		AE120MXTPEH/EU	12.0 kW		•		
		AE160MXTPEH/EU	16.0 kW		•		
	3Φ	AE090MXTPGH/EU	9.0 kW				•
		AE160MXTPGH/EU	16.0 kW				

Selecting the right heating system



		Mono / Split R32	TDM Plus R410A
Main Function	A2W Cooling	•	•
	A2W Heating	•	•
	A2W Domestic Hot Water	•	•
	A2A Cooling		•
	Maximum Allowable Indoor unit Connections		up to 7 Indoor unit
Comfort	Colour Display	•	•
	Low Noise ¹	•	•
	Outing	•	•
	Schedule / Holiday Mode	•	•
	Emergency Operation	•	•
Feature	Wi-Fi Kit SmartThings	•	•
	Wired Remote Controller	• ²	• ²
	Zone Controller	•	•
	Mixing Valve ⁴	•	•
	3-Way Valve	•	•
	2-Way Valve ⁴	•	•
	Thermostat Control	•	•
	PV Integrated	•	•
	Smart Grid Ready	•	•
	Energy Consumption Monitoring	•	•
Set FSV with SD Card	•	•	
Smart Install	Smart Checking	•	•

Third Party DHW Tank solutions			
Mono (R32)	Split (R32)	Split (R410A)	TDM Plus (R410A)
•	•	•	•
•	•	•	•
•	•	•	•
			•
			up to 7 Indoor unit
•	•		•
•	•		•
•	•	•	•
•	•	•	•
•	•	•	•
•	•	•	•
• ²	•	•	•
• ³	•	• ³	• ³
•	•	•	•
• ⁴	• ⁴	• ⁴	• ⁴
•	•	•	•
•	•	•	•
•	•		
•	•		
•	•		
•	•	•	•

¹ Sound pressure level is a relative value, depending on the distance and acoustic environment. Sound pressure level may differ depending on operation conditions.
² Wired Remote Controller to be ordered separately. ³ In combination with an external room sensor. ⁴ Not provided by Samsung.

Nomenclature

Indoor units

AE 260 R N W S E G

1 2 3 4 5 6 7 8

1	Classification	AE	EHS
2	Capacity		x1/10 kW (3 digits)
			x Litre (3 digits)
3	Year	J	2015
		M	2017
		R	2019
		T	2020
4	Product Type	N	Indoor Unit (NASA)
5	Product Notation	A/X	RAC Wall-Mounted
		J	Console
		L	LSP Duct
		M	MSP Duct
		W	Tank Integrated Hydro Unit
		Y	Wall-Mounted Hydro Unit
6	Feature	D	Standard
		P	
		M	Mono
		S	Split
7	Rating Voltage	T	TDM Plus
		E	1Φ, 220~240 V, 50 Hz
8	Mode	G	3Φ, 380~415 V, 50 Hz
		G	R32 Heat Pump
		H	R410A Heat Pump

Outdoor units

AE 090 R X E D E G

1 2 3 4 5 6 7 8

1	Classification	AE	EHS
2	Capacity	x1/10 kW (3 digits)	
3	Year	J	2015
		M	2017
		R	2019
4	Product Type	X	Outdoor Unit (NASA)
5	Product Notation	E	Split
		T	TDM Plus
		Y	Mono
6	Feature	D	Standard
		P	
7	Rating Voltage	E	1Φ, 220–240 V, 50 Hz
		G	3Φ, 380–415 V, 50 Hz
8	Mode	G	R32 Heat Pump
		H	R410A Heat Pump

ClimateHub Features

Compact Design

The Samsung ClimateHub solution is built around a compact tank integrated hydro unit, with a large volume domestic hot water tank of either 200 L or 260 L. The compact and modular design makes for straightforward kitchen or utility room integration.

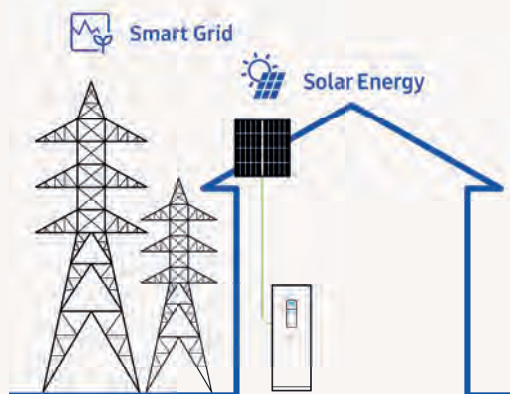

Smart Grid Ready and PV Enabled

A Smart Grid efficiently integrates the behaviour and actions of all the users connected to it. Smart Grid readiness enables users to benefit from an economically efficient and sustainable power supply. Thanks to the PV (Photovoltaic or 'solar' energy) enabled feature, the system can be connected to solar panels, saving energy through renewable sources.¹

¹ The usage of the PV Enabled feature requires additional third party equipment to be installed.

Smooth Servicing

With a conveniently placed servicing window and intuitive servicing options available through the use of a Micro SD card or the Samsung S-Checker Mobile App, troubleshooting and start-up can be done easily from the front of the unit.¹

¹ Please refer to your direct Samsung contact person for more information about the S-Checker Mobile App.

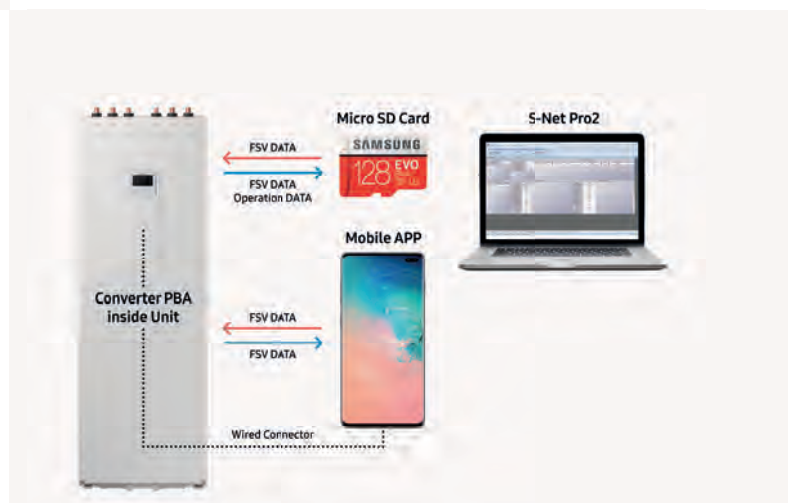

Intuitive Control

Samsung's touch controller comes equipped with multiple language options and bright colour display – enabling temperature settings, energy monitoring, summer time setting and quick error monitoring.¹

¹ The image shows an application example and is for illustrative purposes only. Please always check latest information for understanding availability of language versions.

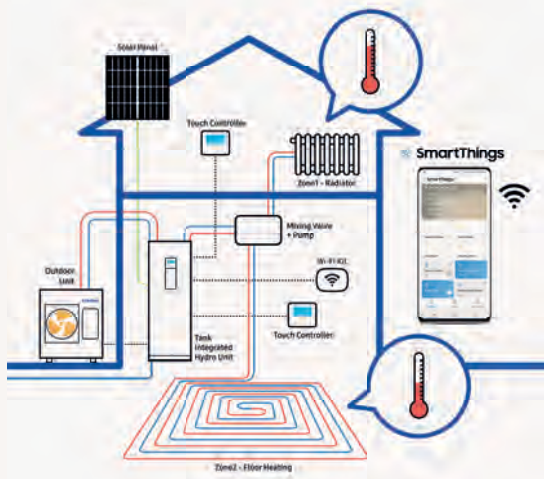

Smart Connectivity

The touch controller enables users to manage different temperature settings per zone, meaning high-temperature radiators and low-temperature floor heating can be utilised efficiently. With the optional Wi-Fi Kit, different aspects of the system, including controlling and monitoring up to 16 indoor units through the Samsung SmartThings App.¹

¹ A Wi-Fi connection and Samsung SmartThings application account are required. Wi-Fi Kit to be ordered separately. Requires iOS 10.0 or later & Android 5.0 or later.

Quiet Operation

In order to meet increasingly strict sound level requirements, Samsung ClimateHub allows to reduce noise levels using the 4-Step Quiet Operation mode¹. Subject to specific models and particular operation conditions, it is possible to achieve levels as low as 35 dB(A)².

¹ ClimateHub Mono and TDM Plus has a 3-Step Quiet Operation mode. ² Sound pressure levels are subject to execution and operating conditions.

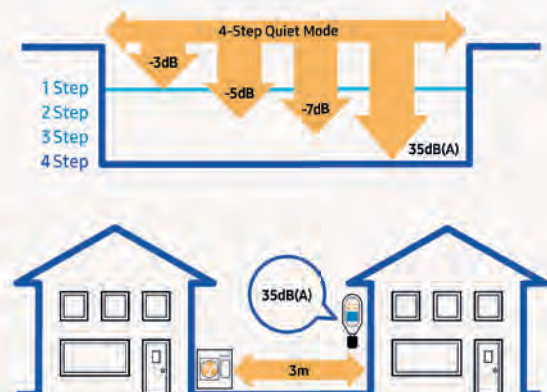



Comfortably cool. Surprisingly still.

Samsung introduces a completely new WindFree™ wall-mounted model for its EHS TDM Plus product range. Equipped with WindFree™ technology, the micro-holes spread fresh air gently and evenly to enhance indoor comfort for ultimate indoor climate convenience.



Step 1

The front panel opens, and Fast Cooling mode cools the room quickly from corner to corner.



Step 2

The set temperature is reached in Fast Cooling mode, and the front panel closes.



Step 3

WindFree™ mode spreads fresh air uniformly through thousands of micro-holes.



WindFree™ Cooling

WindFree™ technology enhances your indoor comfort by using thousands of micro-holes to disperse fresh air uniformly without any unpleasant blasts of cold wind. In WindFree™ mode, air is spread softly and silently, creating a 'Still Air' environment¹ that provides you total well-being day and night.



Easy Control

Samsung WindFree™ is designed to make life easier. It can be operated via wired or wireless controllers that feature advanced functions for a convenient control of indoor climates. Temperatures can also be managed remotely using the SmartThings App². Turning it on and off, selecting the cooling mode or scheduling its operation is just one touch away.



Easy Installation

The WindFree™ Deluxe can be easily mounted through its snap-fit design and roller bracket. The installation process is simplified to fit in effortlessly to the exact position. With an easy-to-remove front grill and a separate cover panel, installers can minimise product damage and reduce service time.

¹ASHRAE (American Society of Heating, Refrigerating, and Air-Conditioning Engineers) defines "Still Air" as air currents at speeds below 0.15m/s which lacks the presence of cold drafts.

²A Wi-Fi connection and Samsung SmartThings application account are required. Wi-Fi Kit to be ordered separately. Requires iOS 10.0 or later & Android 5.0 or later.



Wi-Fi Kit 2.0 – Mobile Remote Control and Monitoring Solution

You can remotely control and monitor up to 16 indoor units with ease by using the SmartThings App².

Enhanced Convenience

The voice command feature is available through a smartphone with Bixby¹. Temperatures can also be managed remotely anytime, and anywhere, using the SmartThings app².

Personalised Climate Environment

Operates in your preferred mode according to the user settings. The geofencing functionality allows the room temperature to be automatically set at the desired level when the user approaches within a preset distance from the building. The Wi-Fi-Kit (optional) is mandatory to enable a multi-device experience interoperable with smart appliances.

Energy Usage Monitoring³

Energy usage can be monitored daily, weekly and monthly at a glance.

Provides ease of installation

Allows for easy setup possible for up to 16 indoor units.



¹ App Voice Recognition: Bixby voice is an intelligent voice assistant that helps you use the device more conveniently.

¹ Currently Voice control is supported in English (US, UK, Indian), Chinese, Korean, French, German, Italian, Spanish and Portuguese. ² A Wi-Fi connection and Samsung SmartThings application account are required. Wi-Fi Kit to be ordered separately. Requires iOS 10.0 or later & Android 5.0 or later. ³ Current and daily, weekly or monthly energy usage of the outdoor unit is reference data calculated for information and reference purposes only.

Energy monitoring

Allows you to view your daily, weekly, and monthly energy usage at a glance



Energy service

Allows you to quickly check the energy usage of multiple devices in your home



Automation

Operates in your preferred mode according to the user settings



Welcome cooling/heating

Pre-cooling and pre-heating before your arrival at home



Mono





Specifications

ClimateHub Mono R32

- Integrated solution for heating and domestic hot water
- Compact unit size with large water tank (200 L & 260 L)
- Intuitive, colour screen touch controller in multiple languages
- Energy monitoring through touch controller
- Smooth servicing through the front-mounted service window
- PV and Smart Grid ready
- 2-zone Control, suitable for floor heating and radiators
- SCOP rating of A+++*
- SmartThings compatible with optional Wi-Fi kit
- Backup heater is included to ensure continuous heating



	Indoor Unit	Outdoor Unit	Controller	AE200RNWMEG/EU AE050RXYDEG/EU	AE200RNWMEG/EU AE080RXYDEG/EU	AE200RNWMEG/EU AE120RXYDEG/EU	
System	Operation	Nominal Capacity	Heating A7/W35 ¹ / A7/W55 ²	kW	5.0/4.3	8.0/7.1	12.0/11.3
			Cooling A35/W18 ¹	kW	5.0	7.5	12.0
	Power Input (Nominal)		Heating A7/W35 ¹ / A7/W55 ²	kW	1.03/1.52	1.77/2.53	2.65/3.73
			Cooling A35/W18 ¹	kW	1.14	1.90	2.77
		COP (Nominal Heating) A7/W35 ¹ / A7/W55 ²	W/W	4.85/2.83	4.52/2.81	4.53/3.03	
		EER (Nominal Cooling) A35/W18 ¹	W/W	4.39	3.95	4.33	
		SCOP LWT 35°C/ 55°C	W/W	4.46/3.2	4.44/3.23	4.69/3.51	
		Seasonal Space Heating enr. efficiency η _s LWT 35°C/ 55°C	ETA%	175/125	175/126	185/138	
		Seasonal Space Heating Eff. class * LWT 35°C/ 55°C	-	A+++ / A++	A+++ / A++	A+++ / A++	
	Current	MCA	A	16.00	22.00	28.00	
		MFA	A	20.00	27.50	35.00	
		Water Flow Rate	Low / Medium temperature	L/min	14.4/7.8	23.1/12.8	34.6/20.4
	Leaving Water Temperature ³	Heating	°C	15-65	15-65	15-65	
		Cooling	°C	5-25	5-25	5-25	
	Functions	Smart Grid Ready / PV Enabled	-	•	•	•	
3-Step Quiet Mode		-	•	•	•		
2-zone Control		-	•	•	•		
Tank Integrated Hydro Unit	Power Supply	Φ, #, V, Hz	1Φ, 2, 220-240 V, 50 Hz	1Φ, 2, 220-240 V, 50 Hz	1Φ, 2, 220-240 V, 50 Hz		
	Water Tank Volume	litres	200	200	200		
	Declared Load Profile	L/XL	L	L	L		
	Average water heating efficiency η _{wh}	ETA%	115	115	110		
	Average Energy Efficiency Class	-	A	A	A		
	Sound	Sound Pressure ⁴	Heating Std	dB(A)	26	26	30
			Cooling Std	dB(A)	26	26	30
	Sound Power	Heating Std	dB(A)	40	40	44	
			Heater	Back-up heater Capacity	Default (Option)	kW	2 (4/6)
	Piping	Water Pipe (Space Heating)	Inlet/ Outlet	Φ, mm	28/28	28/28	28/28
Water pipe (DHW)		Inlet/ Outlet	Φ, mm	22/22	22/22	22/22	
Dimensions	Net Weight	kg	130.0	130.0	130.0		
	Net Dimensions (WxHxD)	mm	595 x 1,800 x 700	595 x 1,800 x 700	595 x 1,800 x 700		
Outdoor Unit	Power Supply	Φ, V, Hz	1Φ, 220-240 V, 50 Hz	1Φ, 220-240 V, 50 Hz	1Φ, 220-240 V, 50 Hz		
	Compressor	Type	-	BLDC Twin Rotary	BLDC Twin Rotary	BLDC Twin Rotary	
	Base Heater	Capacity	kW	-	0.15	0.15	
	Sound	Sound Pressure ⁴	Heating Std	dB(A)	45	48	50
			Cooling Std	dB(A)	45	48	50
		Sound Power	Heating Std	dB(A)	61	63	64
	Dimensions	Net Weight	kg	58.5	76.0	110.0	
		Net Dimensions (WxHxD)	mm	880 x 798 x 310	940 x 998 x 330	940 x 1,420 x 330	
	Refrigerant	Type	-	R32 (Fluorinated greenhouse gas, GWP=675)			
		Factory Charging	tCO ₂ e	0.68	0.78	1.49	
			kg	1.00	1.15	2.20	
	Piping	Water Pipe (Space Heating)	Inlet/ Outlet	Φ, mm	28/28	28/28	28/28
	Operation	Ambient Temperature	Heating	°C	-25-35	-25-35	-25-35
Cooling			°C	10-46	10-46	10-46	
DHW			°C	-25-43	-25-43	-25-43	

Accessories



Touch Controller	Touch Controller	DMS2.5	Wi-Fi Kit	External Room Sensor	Backup Heater (4/6kW)
MWR-WW10N	MCM-A300N	MIM-D01AN	MIM-H04EN	MRW-TA	MHC-*00FE



AE200RNWMEG/EU AE160RXYDEG/EU MWR-WW10N	AE260RNWMEG/EU AE080RXYDEG/EU MWR-WW10N	AE260RNWMEG/EU AE120RXYDEG/EU MWR-WW10N	AE260RNWMEG/EU AE160RXYDEG/EU MWR-WW10N
16.0/15.0	8.0/7.1	12.0/11.3	16.0/15.0
14.0	7.5	12.0	14.0
3.62/5.18	1.77/2.53	2.65/3.73	3.62/5.18
3.28	1.90	2.77	3.28
4.42/2.90	4.52/2.81	4.53/3.03	4.42/2.90
4.27	3.95	4.33	4.27
4.48/3.53	4.44/3.23	4.69/3.51	4.48/3.53
176/138	175/126	185/138	176/138
A+++ / A++	A+++ / A++	A+++ / A++	A+++ / A++
32.00	22.00	28.00	32.00
40.00	27.50	35.00	40.00
46.2/27.1	23.1/12.8	34.6/20.4	46.2/27.1
15-65	15-65	15-65	15-65
5-25	5-25	5-25	5-25
•	•	•	•
•	•	•	•
•	•	•	•
1Φ, 2, 220-240 V, 50 Hz	1Φ, 2, 220-240 V, 50 Hz	1Φ, 2, 220-240 V, 50 Hz	1Φ, 2, 220-240 V, 50 Hz
200	260	260	260
L	XL	XL	XL
110	123	117	117
A	A	A	A
30	26	30	30
30	26	30	30
44	40	44	44
2 (4/6)	2 (4/6)	2 (4/6)	2 (4/6)
28/28	28/28	28/28	28/28
22/22	22/22	22/22	22/22
130.0	140.0	140.0	140.0
595 x 1,800 x 700	595 x 1,800 x 700	595 x 1,800 x 700	595 x 1,800 x 700
1Φ, 220-240 V, 50 Hz	1Φ, 220-240 V, 50 Hz	1Φ, 220-240 V, 50 Hz	1Φ, 220-240 V, 50 Hz
BLDC Twin Rotary	BLDC Twin Rotary	BLDC Twin Rotary	BLDC Twin Rotary
0.15	0.15	0.15	0.15
52	48	50	52
54	48	50	54
66	63	64	66
110.0	76.0	110.0	110.0
940 x 1,420 x 330	940 x 998 x 330	940 x 1,420 x 330	940 x 1,420 x 330
	R32 (Fluorinated greenhouse gas, GWP=675)		
1.49	0.78	1.49	1.49
2.20	1.15	2.20	2.20
28/28	28/28	28/28	28/28
-25-35	-25-35	-25-35	-25-35
10-46	10-46	10-46	10-46
-25-43	-25-43	-25-43	-25-43



* A+++ energy label is available according to EU No. 811/2013 label classification 2019, on a scale from D to A+++

¹ A2W Condition : (Heating) Water In/Out 30°C/35°C, Outdoor Air 7°C[DB]/6°C[WB]; (Cooling) Water In/Out 23°C/18°C, Outdoor Air 35°C[DB].

² A2W Condition : (Heating) Water In/Out 47°C/55°C, Outdoor Air 7°C[DB]/6°C[WB].

³ 65°C down to +10°C (max. 60°C down to -5°C)

⁴ Sound pressure level is obtained in an anechoic room. Sound pressure level is a relative value, depending on the distance and acoustic environment. Sound pressure level may differ depending on operation conditions.

Specifications

ClimateHub Mono (Continued)

R32



		Indoor Unit		AE260RNWMGG/EU		AE260RNWMGG/EU		AE260RNWMGG/EU	
		Outdoor Unit		AE080RXYDGG/EU		AE120RXYDGG/EU		AE160RXYDGG/EU	
		Controller		MWR-WW10N		MWR-WW10N		MWR-WW10N	
System	Operation	Nominal Capacity	Heating A7/W35 ¹ / A7/W55 ²	kW	8.0/7.1	12.0/11.3	16.0/15.0		
			Cooling A35/W18 ¹	kW	7.5	12.0	14.0		
		Power Input (Nominal)	Heating A7/W35 ¹ / A7/W55 ²	kW	1.77/2.53	2.65/3.73	3.62/5.18		
			Cooling A35/W18 ¹	kW	1.90	2.77	3.28		
		COP (Nominal Heating) A7/W35 ¹ / A7/W55 ²		W/W	4.52/2.81	4.53/3.03	4.42/2.90		
		EER (Nominal Cooling) A35/W18 ¹		W/W	3.95	4.33	4.27		
		SCOP LWT 35°C/ 55°C		W/W	4.44/3.23	4.69/3.51	4.48/3.53		
		Seasonal Space Heating enr. efficiency η _s LWT 35°C/ 55°C		ETA%	175/126	185/138	176/138		
		Seasonal Space Heating Eff. class * LWT 35°C/ 55°C		-	A+++ / A++	A+++ / A++	A+++ / A++		
		Current	MCA	A	10.00	10.00	12.00		
	MFA		A	16.10	16.10	16.10			
	Water Flow Rate	Low / Medium temperature		L/min	23.1/12.8	34.6/20.4	46.2/27.1		
		Leaving Water Temperature ²	Heating	°C	15-65	15-65	15-65		
	Cooling		°C	5-25	5-25	5-25			
	Functions	Smart Grid Ready / PV Enabled		-	•	•	•		
3-Step Quiet Mode		-	•	•	•				
2-zone Control		-	•	•	•				
Tank Integrated Hydro Unit	Power Supply		Φ, #, V, Hz	3Φ, 4, 380-415 V, 50 Hz	3Φ, 4, 380-415 V, 50 Hz	3Φ, 4, 380-415 V, 50 Hz			
	Water Tank Volume		litres	260	260	260			
	Declared Load Profile		L/XL	XL	XL	XL			
	Average water heating efficiency η _{wh}		ETA%	123	117	117			
	Average Energy Efficiency Class		-	A	A	A			
	Sound	Sound Pressure ⁴	Heating Std	dB(A)	26	30	30		
			Cooling Std	dB(A)	26	30	30		
	Heater	Back-up heater Capacity	Default (Option)	kW	6	6	6		
	Piping	Water Pipe (Space Heating)	Inlet/ Outlet	Φ, mm	28/28	28/28	28/28		
Water pipe (DHW)		Inlet/ Outlet	Φ, mm	22/22	22/22	22/22			
Dimensions	Net Weight		kg	140.0	140.0	140.0			
	Net Dimensions (WxHxD)		mm	595 x 1,800 x 700	595 x 1,800 x 700	595 x 1,800 x 700			
Outdoor Unit	Power Supply		Φ, V, Hz	3Φ, 380-415 V, 50 Hz	3Φ, 380-415 V, 50 Hz	3Φ, 380-415 V, 50 Hz			
	Compressor	Type	-	BLDC Twin Rotary	BLDC Twin Rotary	BLDC Twin Rotary			
	Base Heater	Capacity	kW	0.15	0.15	0.15			
	Sound	Sound Pressure ⁴	Heating Std	dB(A)	48	50	52		
			Cooling Std	dB(A)	48	50	54		
			Heating Std	dB(A)	63	64	66		
	Dimensions	Net Weight		kg	75.0	111.0	111.0		
		Net Dimensions (WxHxD)		mm	940 x 998 x 330	940 x 1,420 x 330	940 x 1,420 x 330		
	Refrigerant	Type		R32 (Fluorinated greenhouse gas, GWP=675)					
		Factory Charging	tCO ₂ e	kg	0.78	1.49	1.49		
					1.15	2.20	2.20		
	Piping	Water Pipe (Space Heating)	Inlet/ Outlet	Φ, mm	28/28	28/28	28/28		
	Operation	Ambient Temperature		Heating	°C	-25-35	-25-35	-25-35	
		Cooling	°C	10-46	10-46	10-46			
		DHW	°C	-25-43	-25-43	-25-43			



* A+++ energy label is available according to EU No. 811/2013 label classification 2019, on a scale from D to A+++

¹ A2W Condition : (Heating) Water In/Out 30°C/35°C, Outdoor Air 7°C[DB]/6°C[WB]; (Cooling) Water In/Out 23°C/18°C, Outdoor Air 35°C[DB].

² A2W Condition : (Heating) Water In/Out 47°C/55°C, Outdoor Air 7°C[DB]/6°C[WB].

³ 65°C down to +10°C (max. 60°C down to -5°C)

⁴ Sound pressure level is obtained in an anechoic room. Sound pressure level is a relative value, depending on the distance and acoustic environment. Sound pressure level may differ depending on operation conditions.

Project: Atico en el Retiro (Spain)
 Project Architecture: ÁBATON
 Interior Design: BATAVIA
 Photography: Belén Imaz

Specifications

Mono with Third Party DHW Tank R32

- Intuitive, colour screen touch controller in multiple languages
- Energy monitoring through touch controller
- PV and Smart Grid ready
- 2-zone Control, suitable for floor heating and radiators
- SmartThings compatible with optional Wi-Fi kit



		Outdoor Unit		AE050RXYDEG/EU		AE080RXYDEG/EU		AE120RXYDEG/EU	
		Control Kit		MIM-E03CN		MIM-E03CN		MIM-E03CN	
System	Operation	Nominal Capacity	Heating A7/W35 ¹ / A7/W55 ²	kW	5.0/4.3	8.0/7.1	12.0/11.3		
			Cooling A35/W18 ¹	kW	5.0	7.5	12.0		
		Power Input (Nominal)	Heating A7/W35 ¹ / A7/W55 ²	kW	1.03/1.52	1.77/2.53	2.65/3.73		
			Cooling A35/W18 ¹	kW	1.14	1.90	2.77		
		COP (Nominal Heating) A7/W35 ¹ / A7/W55 ²		W/W	4.85/2.83	4.52/2.81	4.55/3.03		
		EER (Nominal Cooling) A35/W18 ¹		W/W	4.39	3.95	4.33		
		Seasonal space heating enr. efficiency η _s LWT 35°C/ 55°C		ETA%	175/ 125	175/126	185/ 138		
		Seasonal space heating eff. class** LWT 35°C/ 55°C		-	A+++ / A++	A+++ / A++	A+++ / A++		
		Current	MCA	A	16.00	22.00	28.00		
			MFA	A	20.00	27.50	35.00		
	Leaving Water Temperature ³	Heating	°C	15-65	15-65	15-65			
		Cooling	°C	5-25	5-25	5-25			
	Functions	Smart Grid Ready / PV Enabled	-	•	•	•			
		3-Step Quiet Mode	-	•	•	•			
2-zone Control		-	•	•	•				
Outdoor Unit	Power Supply		Φ, V, Hz	1Φ, 220-240 V, 50 Hz	1Φ, 220-240 V, 50 Hz	1Φ, 220-240 V, 50 Hz			
	Compressor	Type	-	BLDC Twin Rotary	BLDC Twin Rotary	BLDC Twin Rotary			
	Base Heater	Capacity	kW	-	0.15	0.15			
	Sound	Sound Pressure ⁴	Heating Std	dB(A)	45	48	50		
			Cooling Std	dB(A)	45	48	50		
		Sound Power	Heating Std	dB(A)	61	63	64		
	Dimensions	Net Weight	kg	58.5	76.0	110.0			
		Net Dimensions (WxHxD)	mm	880 x 798 x 310	940 x 998 x 330	940 x 1,420 x 330			
	Piping	Water Pipe	Inlet/ Outlet	Φ, mm	25/ 25	25/ 25	25/ 25		
	Refrigerant	Type			R32 (Fluorinated greenhouse gas, GWP=675)				
		Factory Charging		tCO ₂ e	0.68	0.78	1.49		
				kg	1.00	1.15	2.20		
	Operation	Ambient Temperature	Heating	°C	-25-35	-25-35	-25-35		
Cooling			°C	10-46	10-46	10-46			
DHW			°C	-25-43	-25-43	-25-43			

Accessories



Mono Control Kit

Touch Controller

DMS2.5

Wi-Fi Kit

External Room Sensor

MIM-E03CN

MCM-A300N

MIM-D01AN

MIM-H04EN

MRW-TA



AE160RXYDEG/EU

AE080RXYDGG/EU

AE120RXYDGG/EU

AE160RXYDGG/EU

MIM-E03CN

MIM-E03CN

MIM-E03CN

MIM-E03CN

16.0/15.0

8.0/7.1

12.0/11.3

16.0/15.0

14.0

7.5

12.0

14.0

3.62/5.18

1.77/2.53

2.65/3.73

3.62/5.18

3.28

1.90

2.77

3.28

4.42/2.90

4.52/2.81

4.53/3.03

4.42/2.90

4.27

3.95

4.33

4.27

176/138

175/126

185/138

176/138

A+++ / A++

A+++ / A++

A+++ / A++

A+++ / A++

32.00

10.00

10.00

12.00

40.00

16.10

16.10

16.10

15-65

15-65

15-65

15-65

5-25

5-25

5-25

5-25

•

•

•

•

•

•

•

•

•

•

•

•

1Φ, 220-240 V, 50 Hz

3Φ, 380-415 V, 50 Hz

3Φ, 380-415 V, 50 Hz

3Φ, 380-415 V, 50 Hz

BLDC Twin Rotary

BLDC Twin Rotary

BLDC Twin Rotary

BLDC Twin Rotary

0.15

0.15

0.15

0.15

52

48

50

52

54

48

50

54

66

63

64

66

110.0

75.0

111.0

111.0

940 x 1,420 x 330

940 x 998 x 330

940 x 1,420 x 330

940 x 1,420 x 330

25/ 25

25/ 25

25/ 25

25/ 25

R32 (Fluorinated greenhouse gas, GWP=675)

1.49

0.78

1.49

1.49

2.20

1.15

2.20

2.20

-25-35

-25-35

-25-35

-25-35

10-46

10-46

10-46

10-46

-25-43

-25-43

-25-43

-25-43



* A+++ energy label is available according to EU No. 811/2013 label classification 2019, on a scale from D to A+++

¹ A2W Condition : (Heating) Water In/Out 30°C/35°C, Outdoor Air 7°C[DB]/6°C[WB]; (Cooling) Water In/Out 23°C/18°C, Outdoor Air 35°C[DB].

² A2W Condition : (Heating) Water In/Out 47°C/55°C, Outdoor Air 7°C[DB]/6°C[WB].

³ 65°C down to +10°C (max. 60°C down to -5°C)

⁴ Sound pressure level is obtained in an anechoic room. Sound pressure level is a relative value, depending on the distance and acoustic environment. Sound pressure level may differ depending on operation conditions.

Dimensional Drawings

Mono Tank Integrated Hydro Unit

AE200/260RNW**G/EU

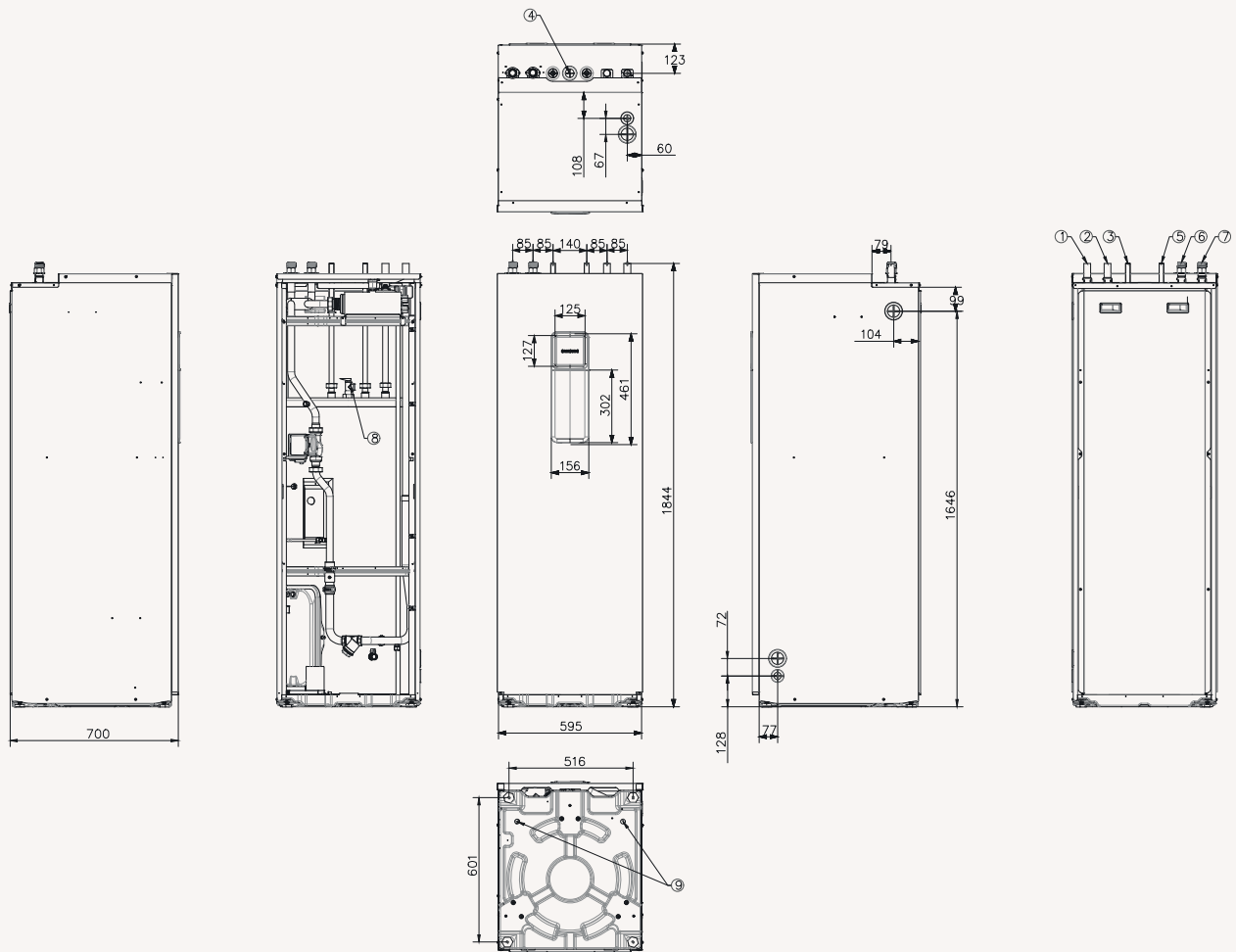

NO	Name	Description	
		AE200RNWMEG/EU	AE260RNWM*G/EU
1	Space heating Inlet	ø28	ø28
2	Space heating Outlet	ø28	ø28
3	DHW Inlet	ø22	ø22
4	Secondary water return	N/A	ø22
5	DHW Outlet	ø22	ø22
6	Heat Pump In	ø28	ø28
7	Heat Pump Out	ø28	ø28
8	T/P v/v	Female PT1/2"	Female PT1/2"
9	Drain Holes	(Option) Connect with the provided drain plug	

Mono Outdoor

AE050RXYDEG/EU

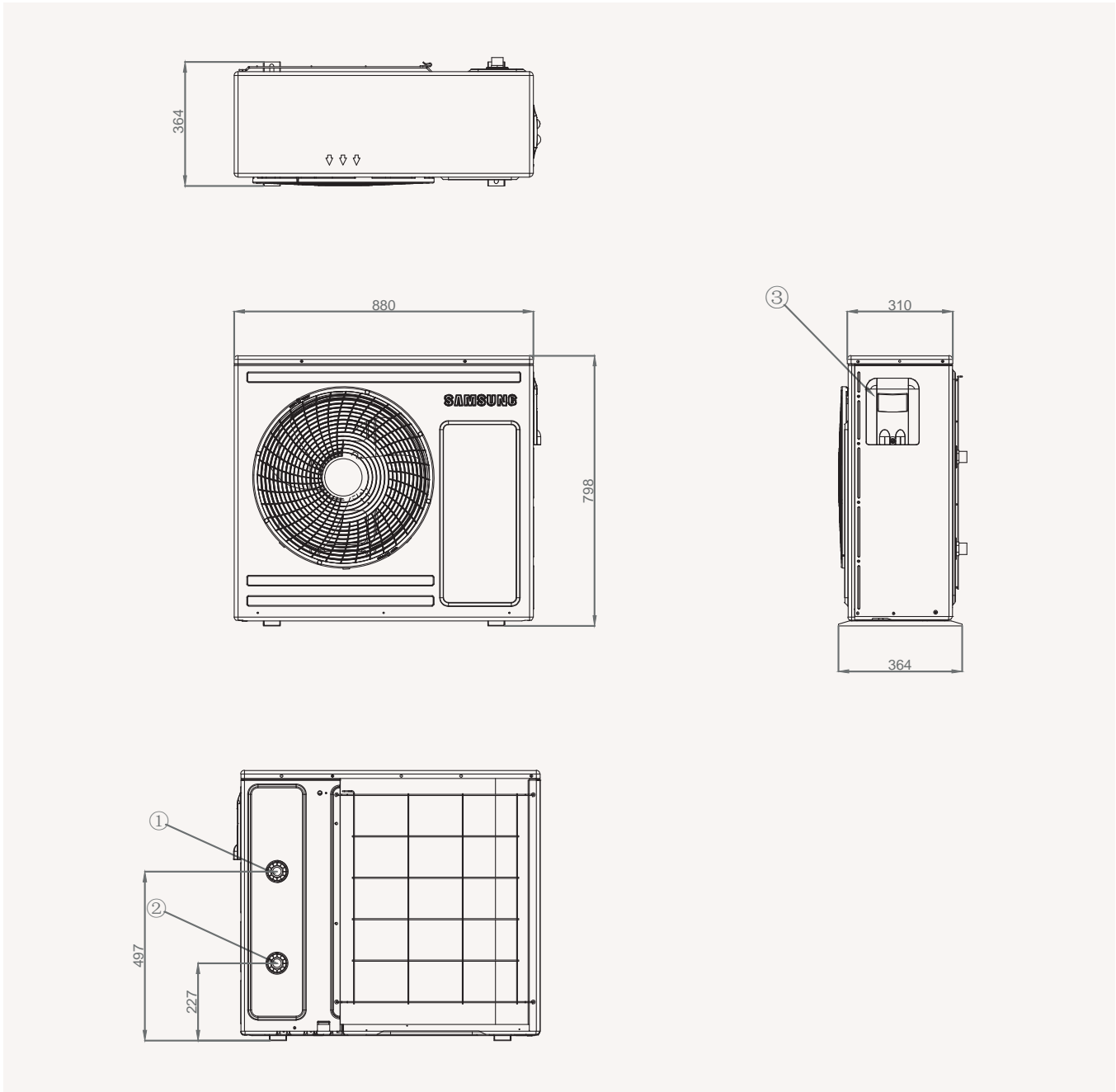

NO	Name	Description
1	Water Pipe(Out)	BSPP male 1"
2	Water Pipe(In)	BSPP male 1"
3	Power & Communication Wiring Conduit Holes	

Dimensional Drawings

Mono Outdoor

AE080RXYD*G/EU

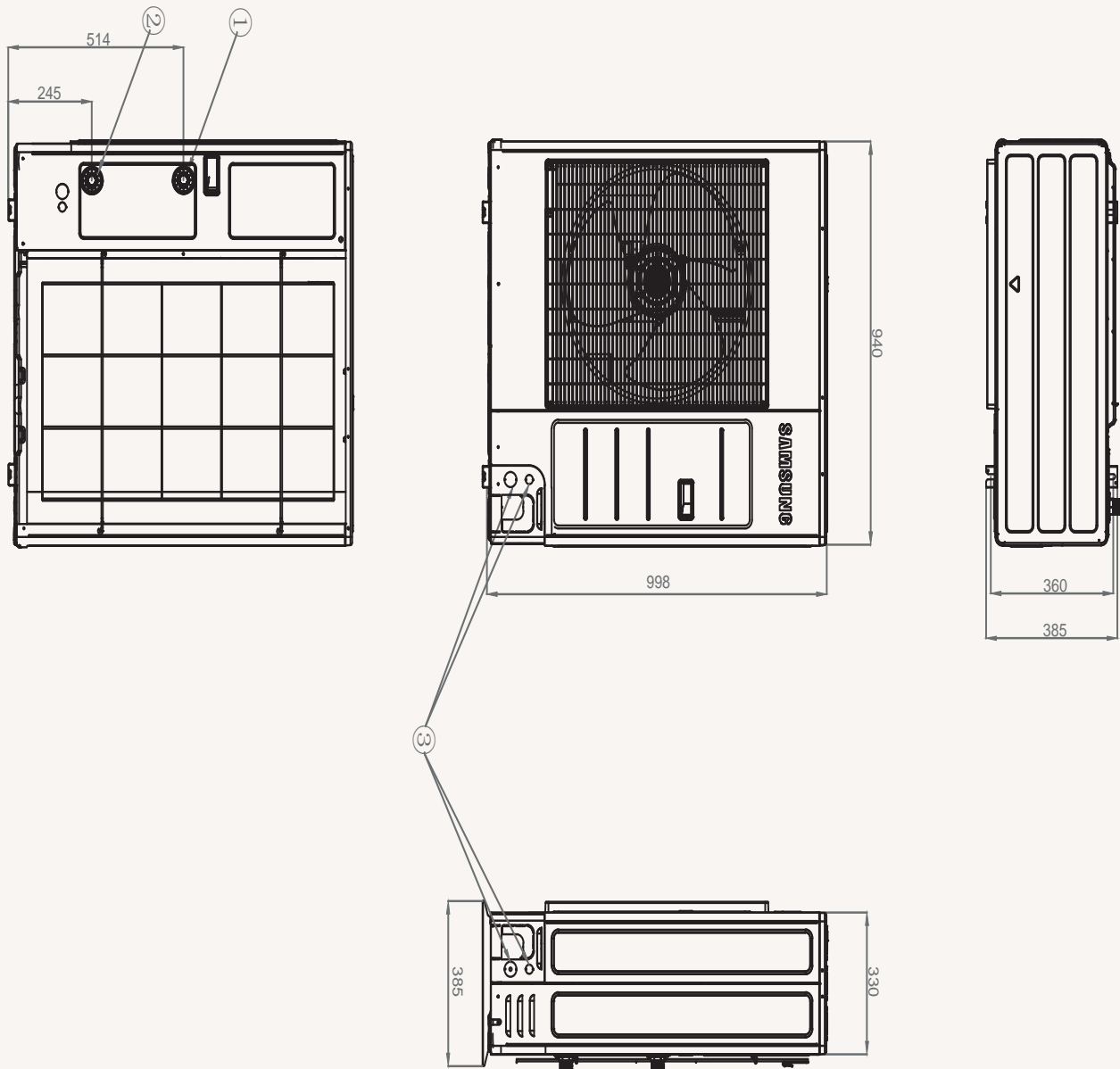

NO	Name	Description
1	Water Pipe(Out)	BSPP male 1"
2	Water Pipe(In)	BSPP male 1"
3	Power & Communication Wiring Conduit Holes	

Mono Outdoor

AE120/160RXYD*G/EU

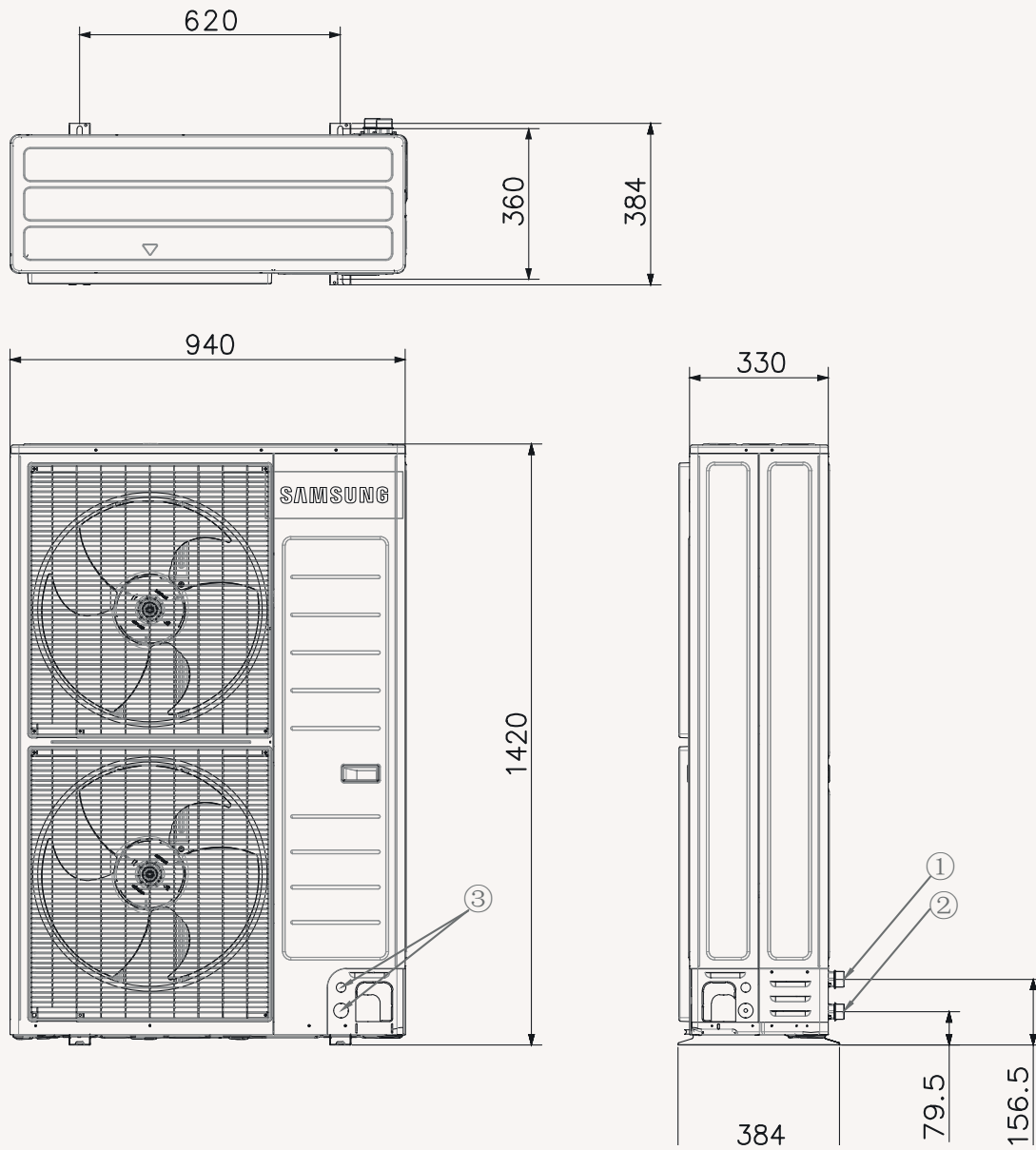

NO	Name	Description
1	Water Pipe(Out)	BSPP male 1"
2	Water Pipe(In)	BSPP male 1"
3	Power & Communication Wiring Conduit Holes	

Dimensional Drawings

Mono Control Kit

MIM-E03CN

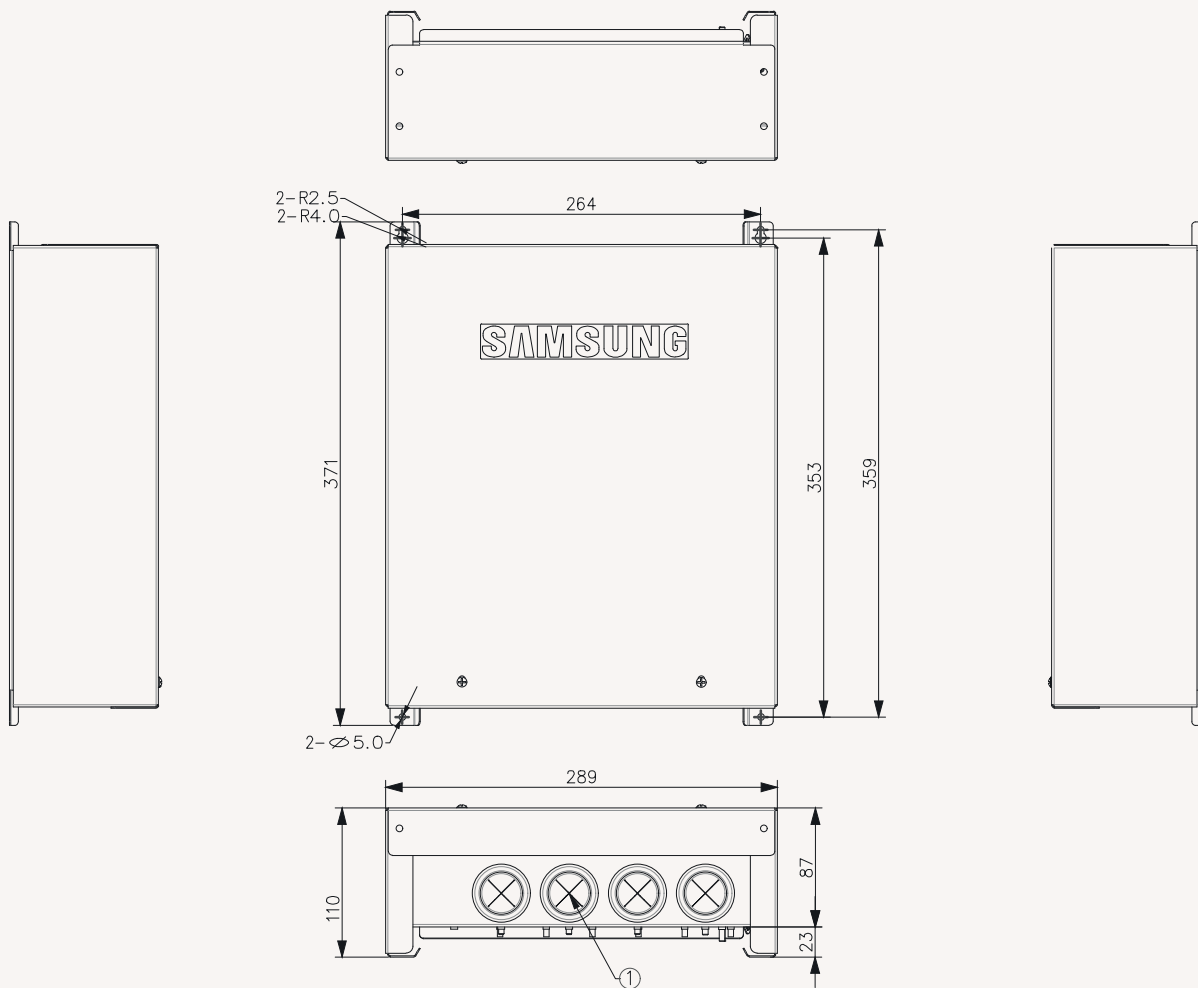

NO	Name
1	Conduit Holes for Wiring (Rubber)



Split





split

Specifications

ClimateHub Split R32

- Integrated solution for heating and domestic hot water
- 4-step quiet operation mode (down to 35 db(A)¹)
- Compact unit size with large water tank (200 L & 260 L)



		Indoor Unit		Outdoor Unit		Controller			
				AE200RNWSEG/EU AE040RXEDEG/EU		AE200RNWSEG/EU AE060RXEDEG/EU		AE200RNWSEG/EU AE090RXEDEG/EU	
				MWR-WW10N		MWR-WW10N		MWR-WW10N	
System	Operation	Nominal Capacity	Heating A7/W35 ¹ / A7/W55 ²	kW	4.4/3.9	6.0/5.2	9.0/8.0		
			Cooling A35/W18 ¹	kW	5.0	6.5	8.7		
		Power Input (Nominal)	Heating A7/W35 ¹ / A7/W55 ²	kW	0.85/1.32	1.22/1.81	1.87/2.73		
			Cooling A35/W18 ¹	kW	1.09	1.47	2.11		
		COP (Nominal Heating) A7/W35 ¹ / A7/W55 ²		W/W	5.20/2.95	4.92/2.87	4.81/2.93		
		EER (Nominal Cooling) A35/W18 ¹		W/W	4.59	4.42	4.12		
		SCOP LWT 35°C/ 55°C		W/W	4.58/3.25	4.58/3.31	4.45/3.24		
		Seasonal space heating enr. efficiency η _s LWT 35°C/ 55°C		ETA%	180/127	180/129	175/127		
		Average Seasonal space heating eff. class ** LWT 35°C/ 55°C		-	A+++ / A++	A+++ / A++	A+++ / A++		
		Current	MCA	A	16.00	16.00	22.00		
	MFA		A	20.00	20.00	27.50			
	Leaving Water Temperature ³	Heating	°C	15-65	15-65	15-65			
		Cooling	°C	5-25	5-25	5-25			
	Functions	Smart Grid Ready / PV Enabled		-	•	•	•		
		4-Step Quiet Mode		-	•	•	•		
2-zone Control		-	•	•	•				
Tank Integrated Hydro Unit	Power Supply		Φ, #, V, Hz	1Φ, 2, 220-240 V, 50 Hz	1Φ, 2, 220-240 V, 50 Hz	1Φ, 2, 220-240 V, 50 Hz			
	Water Tank Volume		litres	200	200	200			
	Declared Load Profile		L/XL	L	L	L			
	Average water heating efficiency η _{wh}		ETA%	120	120	119			
	Average Energy Efficiency Class		-	A+	A+	A+			
	Heater	Back-up heater Capacity	Default (Option)	kW	2 (4/6)	2 (4/6)	2 (4/6)		
			-	-	-	-			
	Sound	Sound Pressure ⁴	Heating Std	dB(A)	26	26	26		
			Cooling Std	dB(A)	26	26	26		
		Sound Power	Heating Std	dB(A)	40	40	40		
Piping	Water pipe (Space Heating)	Inlet/Outlet	Φ, mm	28/28	28/28	28/28			
	Water pipe (DHW)	Inlet/Outlet	Φ, mm	22/22	22/22	22/22			
Dimensions	Net Weight		kg	136	136	136			
	Net Dimensions (WxHxD)		mm	595 x 1,800 x 700	595 x 1,800 x 700	595 x 1,800 x 700			
Outdoor Unit	Power Supply		Φ, V, Hz	1Φ, 220-240 V, 50 Hz	1Φ, 220-240 V, 50 Hz	1Φ, 220-240 V, 50 Hz			
	Compressor		Type	-	BLDC Twin Rotary	BLDC Twin Rotary	BLDC Twin Rotary		
	Base Heater		Capacity	kW	-	-	0.15		
	Sound	Sound Pressure ⁴	Heating Std	dB(A)	44	47	49		
			Cooling Std	dB(A)	46	47	49		
			Night Mode	dB(A)	<35	35	35		
		Sound Power	Heating Std	dB(A)	58	60	64		
	Dimensions	Net Weight		kg	46.5	46.5	73.0		
		Net Dimensions (WxHxD)		mm	880 x 638 x 310	880 x 638 x 310	940 x 998 x 330		
	Refrigerant		Type	-	R32 (Fluorinated greenhouse gas, GWP=675)				
	Factory Charging			tCO ₂ e	0.81	0.81	0.95		
				kg	1.2	1.2	1.4		
	Piping	Piping Connections	Liquid Pipe	Φ, mm (inch)	6.35 (1/4")	6.35 (1/4")	6.35 (1/4")		
			Gas Pipe	Φ, mm (inch)	15.88 (5/8")	15.88 (5/8")	15.88 (5/8")		
		Piping length (ODU-IDU) ⁵	Max. [Equiv.]	m	30.00	30.00	35.00		
Level difference (IDU-IDU) ⁵		Max.	m	20.00	20.00	20.00			
Operation	Ambient Temperature	Heating	°C	-25-35	-25-35	-25-35			
		Cooling	°C	10-46	10-46	10-46			
		DHW	°C	-25-43	-25-43	-25-43			

Accessories



Touch Controller	Touch Controller	DMS2.5	Wi-Fi Kit	External Room Sensor	Backup Heater (4/6kW)
MWR-WW10N	MCM-A300N	MIM-D01AN	MIM-H04EN	MRW-TA	MHC-*00FE



AE260RNWSEG/EU AE040RXEDEG/EU MWR-WW10N	AE260RNWSEG/EU AE060RXEDEG/EU MWR-WW10N	AE260RNWSEG/EU AE090RXEDEG/EU MWR-WW10N	AE260RNWSGG/EU AE090RXEDGG/EU MWR-WW10N
4.4/3.9	6.0/5.2	9.0/8.0	9.0/8.0
5.0	6.5	8.7	8.7
0.85/1.32	1.22/1.81	1.87/2.73	1.87/2.73
1.09	1.47	2.11	2.11
5.20/2.95	4.92/2.87	4.81/2.93	4.81/2.93
4.59	4.42	4.12	4.12
4.58/3.25	4.58/3.31	4.45/3.24	4.45/3.24
180/127	180/129	175/127	175/127
A+++ / A++	A+++ / A++	A+++ / A++	A+++ / A++
16.00	16.00	22.00	10.00
20.00	20.00	27.50	16.10
15-65	15-65	15-65	15-65
5-25	5-25	5-25	5-25
•	•	•	•
•	•	•	•
•	•	•	•
1Φ, 2, 220-240 V, 50 Hz	1Φ, 2, 220-240 V, 50 Hz	1Φ, 2, 220-240 V, 50 Hz	3Φ, 4, 380-415 V, 50 Hz
260	260	260	260
XL	XL	XL	XL
123	123	123	123
A+	A+	A+	A+
2 (4/6)	2 (4/6)	2 (4/6)	6
26	26	26	26
26	26	26	26
40	40	40	40
28/28	28/28	28/28	28/28
22/22	22/22	22/22	22/22
146.0	146.0	146.0	146.0
595 x 1,800 x 700	595 x 1,800 x 700	595 x 1,800 x 700	595 x 1,800 x 700
1Φ, 220-240 V, 50 Hz	1Φ, 220-240 V, 50 Hz	1Φ, 220-240 V, 50 Hz	3Φ, 380-415 V, 50 Hz
BLDC Twin Rotary	BLDC Twin Rotary	BLDC Twin Rotary	BLDC Twin Rotary
-	-	0.15	0.15
44	47	49	49
46	47	49	49
<35	35	35	35
58	60	64	64
46.5	46.5	73.0	72.0
880 x 638 x 310	880 x 638 x 310	940 x 998 x 330	940 x 998 x 330
	R32 (Fluorinated greenhouse gas, GWP=675)		
0.81	0.81	0.95	0.95
1.2	1.2	1.4	1.4
6.35 (1/4")	6.35 (1/4")	6.35 (1/4")	6.35 (1/4")
15.88 (5/8")	15.88 (5/8")	15.88 (5/8")	15.88 (5/8")
30.00	30.00	35.00	35.00
20.00	20.00	20.00	20.00
-25-35	-25-35	-25-35	-25-35
10-46	10-46	10-46	10-46
-25-43	-25-43	-25-43	-25-43



*35dB(A) is only applicable for 6kW and 9kW outdoor units down to +4°C stated in 3 m distance in an anechoic environment.

**A+++ energy label is available according to EU No. 811/2013 label classification 2019, on a scale from D to A+++

¹A2W Condition : (Heating) Water In/Out 30°C/35°C, Outdoor Air 7°C[DB]/6°C[WB]; (Cooling) Water In/Out 23°C/18°C, Outdoor Air 35°C[DB].

²A2W Condition : (Heating) Water In/Out 47°C/55°C, Outdoor Air 7°C[DB]/6°C[WB].

³65°C down to +10°C (max. 60°C down to -5°C)

⁴Sound pressure level is obtained in an anechoic room. Sound pressure level is a relative value, depending on the distance and acoustic environment. Sound pressure level may differ depending on operation conditions.

⁵ODU : Outdoor Unit, IDU : Indoor Unit

Specifications

Split with Third Party DHW Tank R32

- Connectable with R32 Split Outdoor Unit in combination of third party Tank
- Competible with thermostats, solar panels and back-up boilers
- Intuitive, colour screen touch controller in multiple languages
- Energy monitoring through touch controller
- PV and Smart Grid ready
- 2-zone Control, suitable for floor heating and radiators
- SmartThings compatible with optional Wi-Fi kit



		Indoor Unit		AE090RNYDEG/EU		AE090RNYDEG/EU		AE090RNYDEG/EU	
		Outdoor Unit		AE040RXEDEG/EU		AE060RXEDEG/EU		AE090RXEDEG/EU	
System	Operation	Nominal Capacity	Heating A7/W35 ¹ / A7/W55 ²	kW	4.4/3.9	6.0/5.2	9.0/8.0		
			Cooling A35/W18 ¹	kW	5.0	6.5	8.7		
		Power Input (Nominal)	Heating A7/W35 ¹ / A7/W55 ²	kW	0.85/1.32	1.22/1.81	1.87/2.73		
			Cooling A35/W18 ¹	kW	1.09	1.47	2.11		
		COP (Nominal Heating) A7/W35 ¹	W/W	5.20/2.95	4.92/2.87	4.81/2.93			
		EER (Nominal Cooling) A35/W18 ¹	W/W	4.59	4.42	4.12			
		Seasonal space heating enr. efficiency η _s LWT 35°C / 55°C	ETA%	180/127	180/129	175/127			
		Seasonal Space Heating Eff. Class LWT 35°C / 55°C	-	A+++ / A++	A+++ / A++	A+++ / A++			
		Current	MCA	A	16.00	16.00	22.00		
			MFA	A	20.00	20.00	27.50		
	Leaving Water Temperature ²	Heating	°C	15-65	15-65	15-65			
		Cooling	°C	5-25	5-25	5-25			
	Functions	Smart Grid Ready / PV Enabled	-	•	•	•			
4-Step Quiet Mode		-	•	•	•				
2-zone Control		-	•	•	•				
Wall-Mounted Hydro Unit	Power Supply		Φ, V, Hz	1Φ, 2, 220-240 V, 50 Hz	1Φ, 2, 220-240 V, 50 Hz	1Φ, 2, 220-240 V, 50 Hz			
	Heater	Back-up heater Capacity	Default (Option)	kW	4	4	4		
	Sound	Sound Pressure ³	Heating Std	dB(A)	26	26	26		
			Cooling Std	dB(A)	26	26	26		
	Sound Power	Heating Std	dB(A)	40	40	40			
			dB(A)	40	40	40			
	Dimensions	Net Weight		kg	45,0	45,0	45,0		
Net Dimensions (WxHxD)			mm	510 x 850 x 315	510 x 850 x 315	510 x 850 x 315			
Piping	Water pipe	Inlet/Outlet	Φ, inch	1+1/4"	1+1/4"	1+1/4"			
Outdoor unit	Compressor	Type	-	BLDC Twin Rotary	BLDC Twin Rotary	BLDC Twin Rotary			
	Base Heater	Capacity	kW	-	-	0.15			
	Sound	Sound Pressure ³	Heating Std	dB(A)	44	47	49		
			Cooling Std	dB(A)	46	47	49		
			Sound Power	Heating Std	dB(A)	58	60	64	
	Dimensions	Net Weight		kg	46.5	46.5	73.0		
		Net Dimensions (WxHxD)		mm	880 x 638 x 310	880 x 638 x 310	940 x 998 x 330		
	Refrigerant	Type			R32 (Fluorinated greenhouse gas, GWP=675)				
		Factory Charging	tCO ₂ e		1.2	1.2	1.4		
			kg		0.81	0.81	0.95		
		Piping	Piping Connections	Liquid Pipe	Φ, mm (inch)	6.35 (1/4")	6.35 (1/4")	6.35 (1/4")	
	Gas Pipe			Φ, mm (inch)	15.88 (5/8")	15.88 (5/8")	15.88 (5/8")		
	Piping length (ODU-IDU) ⁴		Max. [Equiv.]	m	30	30	35		
Level difference (IDU-IDU) ⁴	Max.		m	20	20	20			
Chargeless Length			Φ, mm	15	15	15			
Operation	Ambient Temperature	Heating	°C	-25-35	-25-35	-25-35			
		Cooling	°C	10-46	10-46	10-46			
		DHW	°C	-25-43	-25-43	-25-43			

Accessories



Touch Controller (included)

Touch Controller

DMS2.5

Wi-Fi Kit

External Room Sensor

MWR-WW10N

MCM-A300N

MIM-D01AN

MIM-H04EN

MRW-TA



AE090RNYDGG/EU

AE090RXEDGG/EU

9.0/8.0

8.7

1.87/2.73

2.11

4.81/2.93

4.12

175/127

A+++ / A++

10.00

16.10

15-65

5-25

•

•

•

3Φ, 2, 380-415 V, 50 Hz

6

26

26

40

46.5

510 x 850 x 315

1+1/4"

BLDC Twin Rotary

0.15

49

49

64

72.0

940 x 998 x 330

R32 (Fluorinated greenhouse gas,
GWP=675)

1.4

0.95

6.35 (1/4")

15.88 (5/8")

35

20

15

-25-35

10-46

-25-43



*A+++ energy label is available according to EU No. 811/2013 label classification 2019, on a scale from D to A+++

¹A2W Condition : (Heating) Water In/Out 30°C/35°C, Outdoor Air 7°C[DB]/6°C[WB]; (Cooling) Water In/Out 23°C/18°C, Outdoor Air 35°C[DB].

²A2W Condition : (Heating) Water In/Out 47°C/55°C, Outdoor Air 7°C[DB]/6°C[WB].

³Sound pressure level is obtained in an anechoic room. Sound pressure level is a relative value, depending on the distance and acoustic environment. Sound pressure level may differ depending on operation conditions.

⁴ODU : Outdoor Unit, IDU : Indoor Unit

Specifications

Split with Third Party DHW Tank (R410A)

- Connectable with R410A Split Outdoor Unit in combination of third party Tank
- Compatible with room thermostats, solar pumps, 2- or 3-way valves and back-up boilers



		Indoor Unit		AE160JNYDEH/EU		AE160JNYDGH/EU		AE160JNYDEH/EU	
		Outdoor Unit		AE120JXEDEH/EU		AE120JXEDGH/EU		AE160JXEDEH/EU	
System	Operation	Nominal Capacity	Heating A7/W35 ¹	kW	12.0	12.0	16.0		
			Cooling A35/W18 ¹	kW	12.0	12.0	15.0		
		Power Input (Nominal)	Heating A7/W35 ¹	kW	2.59	2.59	3.76		
			Cooling A35/W18 ¹	kW	3.10	3.10	4.14		
		COP (Nominal Heating) A7/W35 ¹	W/W	4.63	4.63	4.26			
		EER (Nominal Cooling) A35/W18 ¹	W/W	3.87	3.87	3.62			
		Seasonal space heating enr. efficiency η_s LWT 35°C/55°C	ETA%	184/107	184/107	173/115			
		Seasonal Space Heating Eff. Class LWT 35°C/55°C	-		A+++ / A+	A+++ / A+	A++ / A+		
		Current	MCA	A	28.00	10.00	32.00		
			MFA	A	35.00	16.10	37.50		
		Leaving Water Temperature	Heating	°C	25-55	25-55	25-55		
			Cooling	°C	5-25	5-25	5-25		
		Functions	Smart Grid Ready/PV Enabled	-	-	-	-		
3-Step Quiet Mode	-		•	•	•				
2-zone Control ²	-		•	•	•				
Wall-Mounted Hydro Unit	Power Supply		Φ, V, Hz	1Φ, 2, 220-240 V, 50 Hz	3Φ, 2, 380-415 V, 50 Hz	1Φ, 2, 220-240 V, 50 Hz			
	Heater Capacity		kW	6	6	6			
		Sound Pressure ³	Heating Std	dB(A)	33	33	33		
	Cooling Std		dB(A)	33	33	33			
	Sound Power	Heating Std	dB(A)	47	47	47			
	Piping	Water pipe	Inlet/Outlet	Φ, inch	1+1/4"	1+1/4"	1+1/4"		
Dimensions	Net Weight		kg	45.0	46.5	45.0			
	Net Dimensions (WxHxD)		mm	510 x 850 x 315	510 x 850 x 315	510 x 850 x 315			
Outdoor unit	Compressor	Type	-	BLDC Twin Rotary	BLDC Twin Rotary	BLDC Twin Rotary			
	Base Heater Capacity		kW	0.15	0.15	0.15			
		Sound Pressure ³	Heating Std	dB(A)	50	50	52		
	Cooling Std		dB(A)	50	50	54			
	Sound Power	Heating Std	dB(A)	64	64	66			
	Dimensions	Net Weight		kg	100.0	101.5	100.0		
		Net Dimensions (WxHxD)		mm	940 x 1,420 x 330	940 x 1,420 x 330	940 x 1,420 x 330		
	Refrigerant	Type			R410A (Fluorinated greenhouse gas, GWP=2,088)				
		Factory Charging		tCO ₂ e	6.22	6.22	6.22		
				kg	2.98	2.98	2.98		
	Piping	Piping Connections	Liquid Pipe	Φ, mm (inch)	9.52 (3/8")	9.52 (3/8")	9.52 (3/8")		
			Gas Pipe	Φ, mm (inch)	15.88 (5/8")	15.88 (5/8")	15.88 (5/8")		
Piping length (ODU-IDU) ⁴		Max. [Equiv.]	m	50	50	50			
Level difference (IDU-IDU) ⁴		Max.	m	30	30	30			
Chargeless Length			Φ, mm	15	15	15			
Operation	Ambient Temperature	Heating	°C	-25-35	-25-35	-25-35			
		Cooling	°C	10-46	10-46	10-46			
		DHW	°C	-25-43	-25-43	-25-43			

Accessories



EHS Controller (included)

Touch Controller

DMS2.5

Wi-Fi Kit

External Room Sensor

MWR-WW00N

MCM-A300N

MIM-D01AN

MIM-H04EN

MRW-TA



AE160JNYDGH/EU

AE160JXEDGH/EU

16.0

15.0

3.76

4.14

4.26

3.62

173/115

A++ / A+

12.00

16.10

25-55

5-25

-

•

•

3Φ, 2, 380-415 V, 50 Hz

6

33

33

47

1+1/4"

46.5

510 x 850 x 315

BLDC Twin Rotary

0.15

52

54

66

101.5

940 x 1,420 x 330

R410A (Fluorinated greenhouse gas, GWP=2,088)

6.22

2.98

9.52 (3/8")

15.88 (5/8")

50

30

15

-25-35

10-46

-25-43



¹A2W Conditions : (Heating) Water In/Out 30°C/35°C, Outdoor Air 7°C[DB]/6°C[WB]; (Cooling) Water In/Out 23°C/18°C, Outdoor Air 35°C[DB].

²Not provided by Samsung.

³Sound pressure level is obtained in an anechoic room. Sound pressure level is a relative value, depending on the distance and acoustic environment. Sound pressure level may differ depending on operation conditions.

⁴ODU: Outdoor Unit, IDU: Indoor Unit

Dimensional Drawings

Split Tank Integrated Hydro Unit

AE200/260RNW**G/EU

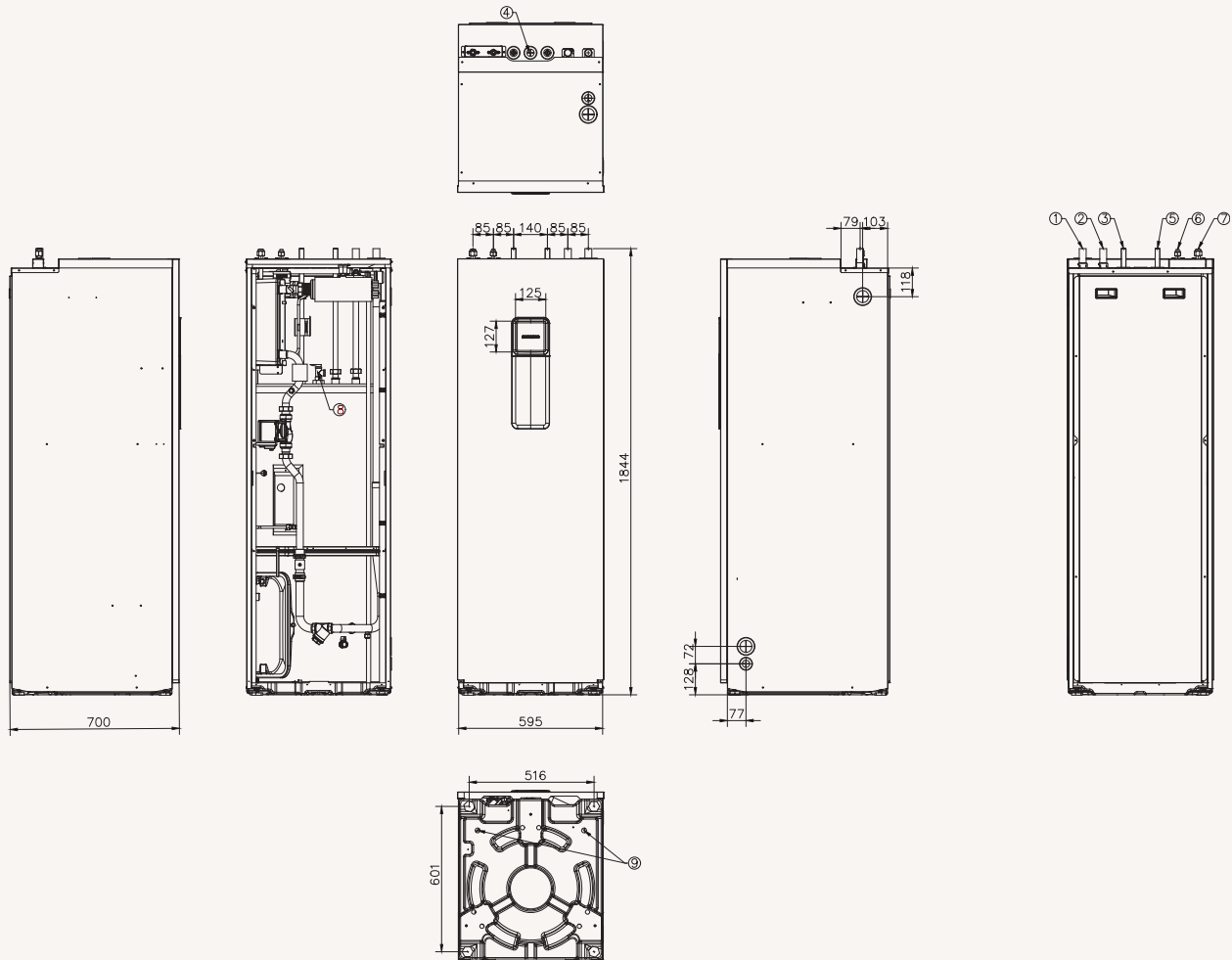

NO	Name	Description	
		AE200RNWSEG/EU	AE260RNWS*G/EU
1	Space heating Inlet	Ø28	Ø28
2	Space heating Outlet	Ø28	Ø28
3	DHW Inlet	Ø22	Ø22
4	Secondary water return	N/A	Ø22
5	DHW Outlet	Ø22	Ø22
6	Refrigerant liquid pipe	Ø9.52	Ø9.52
7	Refrigerant gas pipe	Ø15.88	Ø15.88
8	T/P v/v	Female PT1/2"	Female PT1/2"
9	Drain Holes	(Option) Connect with the provided drain plug	

Split Outdoor

AE040/060RXEDEC/EU

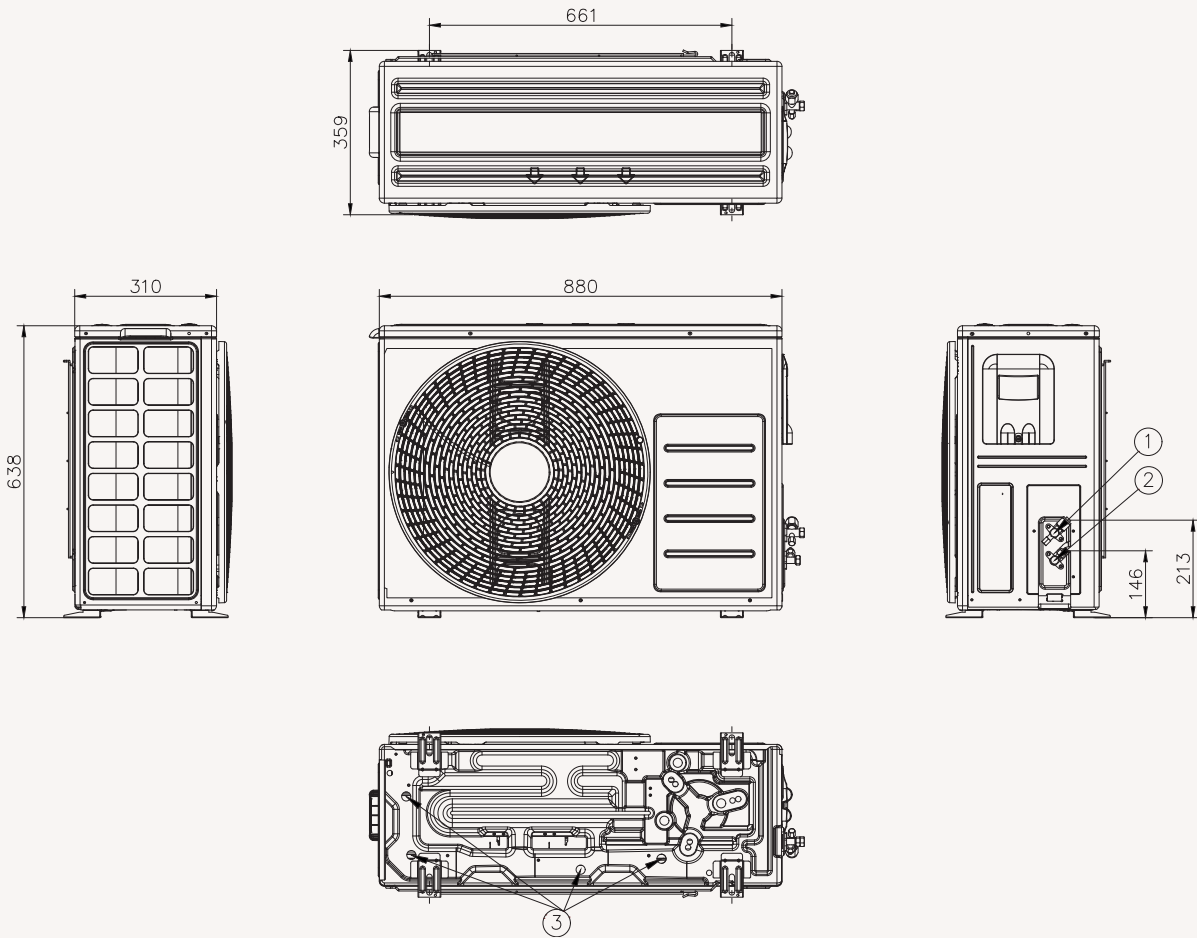

NO	Name	Description
1	Refrigerant liquid pipe	Φ6.35(1/4)
2	Refrigerant gas pipe	Φ15.88(5/8)
3	Drain holes	Connect with the provided drain plug.

Dimensional Drawings

Split Outdoor

AE090RXED*G/EU

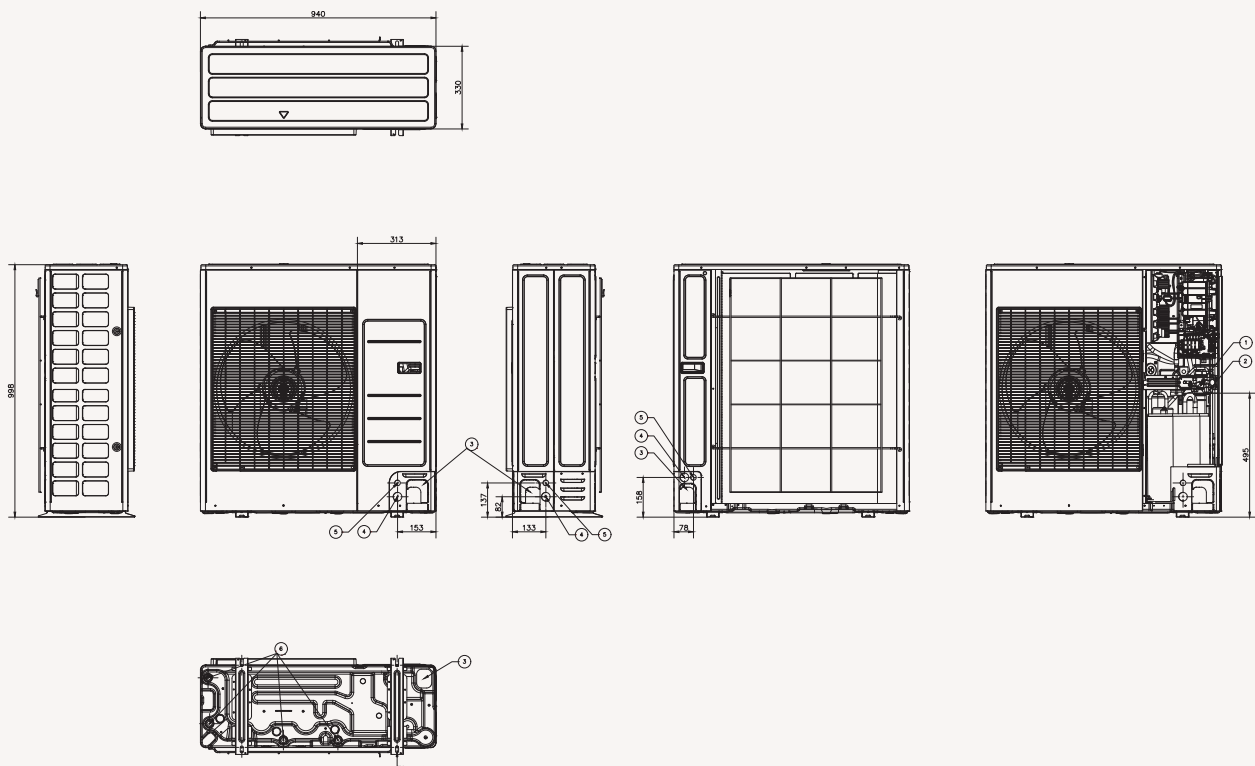

NO	Name	Description
1	Refrigerant gas pipe	Φ6.35(1/4)
2	Refrigerant liquid pipe	Φ15.88(5/8)
3	Piping intake knockout hole	Front / Side / Rear / Bottom
4	Power wiring conduit	Front / Side / Rear, Φ34 [1-3/8]
5	Communication wiring conduit	Front / Side / Rear, Φ22 [7/8]
6	Drain Hole	Connect with the provided drain plug

Split Outdoor

AE120/160JXED*H/EU

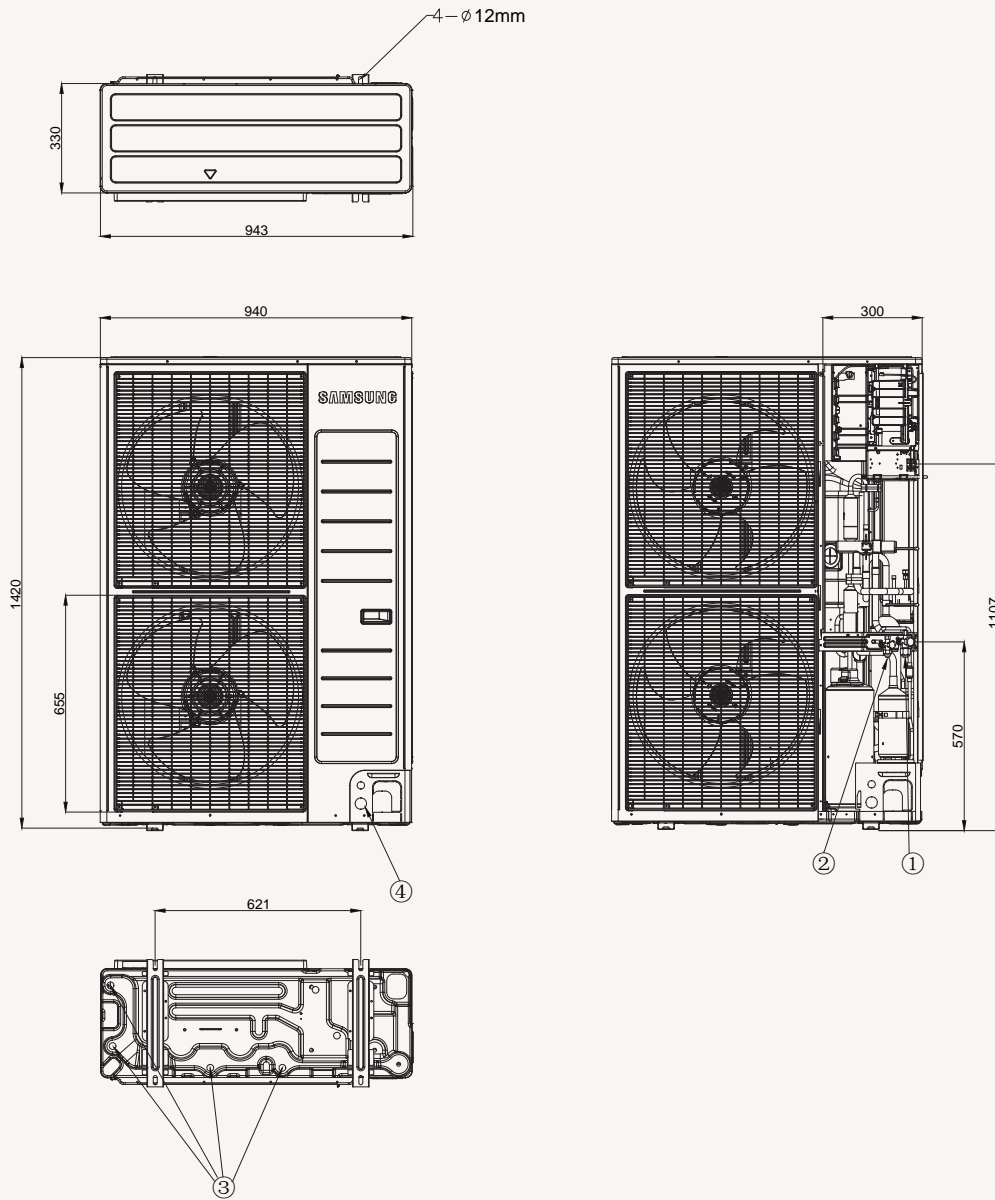

NO	Name	Description
1	Refrigerant gas pipe	φ 15.88
2	Refrigerant liquid pipe	φ 9.52
3	Drain Hole	Connect with the provided drain plug
4	Power wiring conduit	N/A

Dimensional Drawings

Split Wall-Mounted Hydro Unit

AE090RNYD*G/EU, AE160JNYD*H/EU

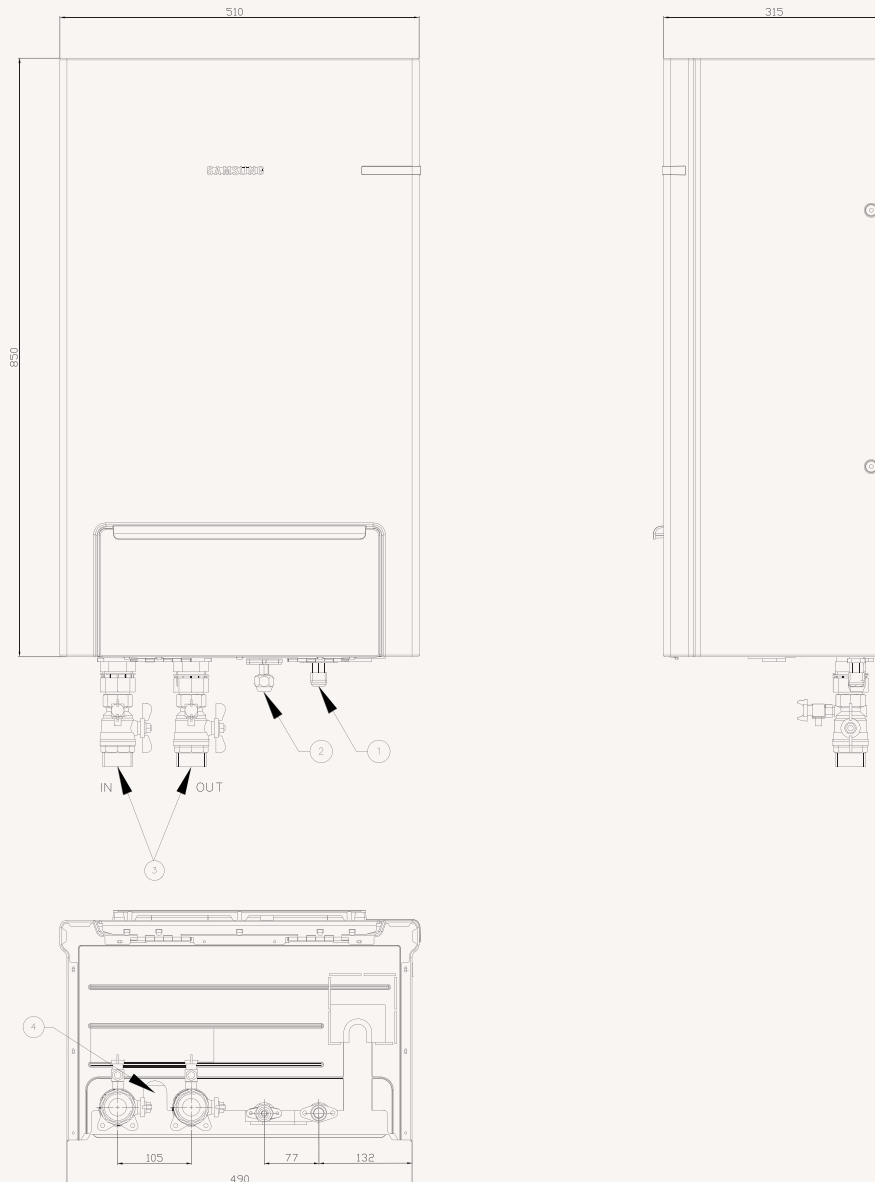

NO	Name
1	Refrigerant gas pipe
2	Refrigerant liquid pipe
3	Water pipe inlet/outlet
4	Drain Hose Connector



TDM Plus

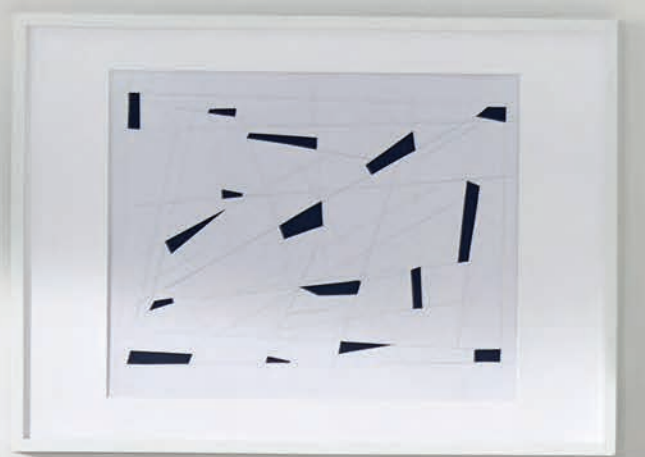



Specifications

ClimateHub TDM Plus (R410A)

- 'All in one' air-to-water and air-to-air system
- PV and Smart Grid ready
- Compact unit size with large water tank (200L & 260L)
- 2-zone control, suitable for floor heating and radiators
- Intuitive, colour screen touch controller in multiple languages
- SCOP rating of A++++*
- Energy monitoring through touch controller
- SmartThings compatible with optional Wi-Fi kit
- Smooth servicing through the front-mounted service window
- Backup heater is included to ensure continuous heating



		Indoor Unit		AE200TNWTEH/EU		AE200TNWTEH/EU	
		Outdoor Unit		AE044MXTPEH/EU		AE066MXTPEH/EU	
		Controller		MWR-WW10N		MWR-WW10N	
System	Operation	Nominal Capacity	Heating A7/W35 ¹ / A7/W55 ²	kW	4.4/ 3.8	6.6/ 4.8	
			Cooling A35/W18 ¹	kW	5.1	6.7	
		Power Input (Nominal)	Heating A7/W35 ¹ / A7/W55 ²	kW	0.93/ 1.37	1.47/ 1.85	
			Cooling A35/W18 ¹	kW	1.03	1.48	
		COP (Nominal Heating) A7/W35 ¹ / A7/W55 ²	W/W	4.73/ 2.80	4.49/ 2.59		
		EER (Nominal Cooling) A35/W18 ¹	W/W	4.95	4.53		
		SCOP LWT 35°C/ 55°C	W/W	4.41/ 2.83	4.41/ 2.96		
		Seasonal space heating enr. efficiency η _s LWT 35°C/ 55°C	ETA%	173/ 110	173/ 115		
		Average Seasonal space heating eff. class ** LWT 35°C/ 55°C	-	A++ / A+	A++ / A+		
		Current	MCA	A	18.00	20.00	
			MFA	A	25.00	25.00	
		Maximum allowable IDU ⁵ connections (Hydro A2W unit not included)	Max. number of IDU ⁵	EA	2	3	
			Total capacity Min. (Cooling)	kW	2.20	3.30	
		Leaving Water Temperature ³	Total capacity Min. (Cooling)	kW	4.40	6.60	
			Heating	°C	15-55	15-55	
Functions	Cooling	°C	5-25	5-25			
	Smart Grid Ready / PV Enabled	-	•	•			
	3-Step Quiet Mode	-	•	•			
	2-zone Control	-	•	•			
Tank Integrated Hydro Unit	Power Supply		Φ, #, V, Hz	1Φ, 2, 220-240 V, 50 Hz	1Φ, 2, 220-240 V, 50 Hz		
	Water Tank Volume		litres	200	200		
	Declared Load Profile		L/XL	L	L		
	Average water heating efficiency η _{wh}		ETA%	115	115		
	Average Energy Efficiency Class		-	A+	A+		
	Heater	Back-up heater Capacity	Default (Option)	kW	2 (4/6)	2 (4/6)	
	Sound	Sound Pressure ⁴	Heating Std	dB(A)	29	29	
			Cooling Std	dB(A)	29	29	
		Sound Power	Heating Std	dB(A)	43	43	
	Piping	Water pipe (Space Heating)	Inlet/Outlet	Φ, inch	1+1/4"	1+1/4"	
Dimensions	Net Weight		kg	137	137		
	Net Dimensions (WxHxD)		mm	595 x 1,800 x 700	595 x 1,800 x 700		
Outdoor Unit	Power Supply		Φ, V, Hz	1Φ, 2, 220-240 V, 50 Hz	1Φ, 2, 220-240 V, 50 Hz		
	Compressor	Type	-	Rotary Comp	Rotary Comp		
	Base Heater	Capacity	-	-	-		
	Sound	Sound Pressure ⁴	Heating Std	dB(A)	47	48	
			Cooling Std	dB(A)	46	47	
		Sound Power	Heating Std	dB(A)	65	67	
	Dimensions	Net Weight		kg	61.0	61.0	
		Net Dimensions (WxHxD)		mm	880 x 793 x 310	880 x 793 x 310	
	Refrigerant	Type		Type	R410A (Fluorinated greenhouse gas, GWP=2,088)	R410A (Fluorinated greenhouse gas, GWP=2,088)	
		Factory Charging		tCO _{2e}	5.43	5.43	
	Piping	Piping Connections	Liquid Pipe	Φ, mm (inch)	9.52 (3/8")	9.52 (3/8")	
			Gas Pipe	Φ, mm (inch)	15.88 (5/8")	15.88 (5/8")	
		Piping length (ODU-IDU) ⁵	Max.[Equiv.]	m	30	30	
		Level difference (IDU-IDU) ⁵	Max.	m	20	20	
		Chargeless length	-	m	10	10	
	Operation	Ambient Temperature A2W	Heating	°C	-25-35	-25-35	
			Cooling	°C	10-46	10-46	
			DHW	°C	-25-43	-25-43	
Ambient Temperature A2A		Heating	°C	-25-24	-25-24		
		Cooling	°C	10-46	10-46		

Accessories



Touch Controller	Touch Controller	DMS2.5	Wi-Fi Kit	External Room Sensor	Backup Heater (4/6kW)
MWR-WW10N	MCM-A300N	MIM-D01AN	MIM-H04EN	MRW-TA	MHC-*00FE



AE200TNWTEH/EU AE090MXTPEH/EU MWR-WW10N	AE200TNWTEH/EU AE090MXTPGH/EU MWR-WW10N	AE260TNWTEH/EU AE044MXTPEH/EU MWR-WW10N	AE260TNWTEH/EU AE066MXTPEH/EU MWR-WW10N
9.0/ 7.7	9.0/ 7.7	4.4/ 3.8	6.6/ 4.8
8.0	8.0	5.1	6.7
2.12/ 2.82	2.12/ 2.82	0.93/ 1.37	1.47/ 1.85
1.85	1.86	1.03	1.48
4.25/ 2.72	4.25/ 2.69	4.73/ 2.80	4.49/ 2.59
4.32	4.30	4.95	4.53
4.42/ 3.01	4.44/ 2.86	4.41/ 2.83	4.41/ 2.96
174/ 117	175/ 111	173/ 110	173/ 115
A++ / A+	A+++ / A+	A++ / A+	A++ / A+
22.00	10.00	18.00	20.00
27.50	16.10	25.00	25.00
4	4	2	3
4.50	4.50	2.20	3.30
9.00	9.00	4.40	6.60
15-55	15-55	15-55	15-55
5-25	5-25	5-25	5-25
•	•	•	•
•	•	•	•
•	•	•	•
1Φ, 2, 220-240 V, 50 Hz	1Φ, 2, 220-240 V, 50 Hz	1Φ, 2, 220-240 V, 50 Hz	1Φ, 2, 220-240 V, 50 Hz
200	200	260	260
L	L	XL	XL
115	115	105	105
A+	A+	A	A
2 (4/6)	2 (4/6)	2 (4/6)	2 (4/6)
29	29	29	29
29	29	29	29
43	43	43	43
1+1/4"	1+1/4"	1+1/4"	1+1/4"
137	137	147	147
595 x 1,800 x 700	595 x 1,800 x 700	595 x 1,800 x 700	595 x 1,800 x 700
1Φ, 2, 220-240 V, 50 Hz	3Φ, 4, 380-415 V, 50 Hz	1Φ, 2, 220-240 V, 50 Hz	1Φ, 2, 220-240 V, 50 Hz
Rotary Comp	Rotary Comp	Rotary Comp	Rotary Comp
-	-	-	-
51	51	47	48
50	50	46	47
69	69	65	67
74.0	76.0	61.0	61.0
940 x 998 x 330	940 x 998 x 330	880 x 793 x 310	880 x 793 x 310
R410A (Fluorinated greenhouse gas, GWP=2,088)			
5.01	5.01	5.43	5.43
2.4	2.4	2.6	2.6
9.52 (3/8")	9.52 (3/8")	9.52 (3/8")	9.52 (3/8")
15.88 (5/8")	15.88 (5/8")	15.88 (5/8")	15.88 (5/8")
30	30	30	30
20	20	20	20
10	10	10	10
-25-35	-25-35	-25-35	-25-35
10-46	10-46	10-46	10-46
-25-43	-25-43	-25-43	-25-43
-25-24	-25-24	-25-24	-25-24
10-46	10-46	10-46	10-46



*35dB(A) is only applicable for 6kW and 9kW outdoor units down to +4°C stated in 3 m distance in an anechoic environment.

**A+++ energy label is available according to EU No. 811/2013 label classification 2019, on a scale from D to A+++

¹A2W Condition : (Heating) Water In/Out 30°C/35°C, Outdoor Air 7°C[DB]/6°C[WB]; (Cooling) Water In/Out 23°C/18°C, Outdoor Air 35°C[DB].

²A2W Condition : (Heating) Water In/Out 47°C/55°C, Outdoor Air 7°C[DB]/6°C[WB].

³65°C down to +10°C (max. 60°C down to -5°C)

⁴Sound pressure level is obtained in an anechoic room. Sound pressure level is a relative value, depending on the distance and acoustic environment. Sound pressure level may differ depending on operation conditions.

⁵ODU : Outdoor Unit, IDU : Indoor Unit

Specifications

ClimateHub TDM Plus (R410A) (Continued)



		Indoor Unit		AE260TNWTEH/EU	AE260TNWTEH/EU	
		Outdoor Unit		AE090MXTPEH/EU	AE120MXTPEH/EU	
		Controller		MWR-WW10N	MWR-WW10N	
System	Operation	Nominal Capacity	Heating A7/W35 ¹ / A7/W55 ²	kW	9.0/ 7.7	12.0/ 10.7
			Cooling A35/W18 ¹	kW	8.0	12.0
		Power Input (Nominal)	Heating A7/W35 ¹ / A7/W55 ²	kW	2.12/ 2.82	2.72/ 3.91
			Cooling A35/W18 ¹	kW	1.85	2.90
		COP (Nominal Heating) A7/W35 ¹ / A7/W55 ²	W/W	4.25/ 2.72	4.41/ 2.74	
		EER (Nominal Cooling) A35/W18 ¹	W/W	4.32	4.14	
		SCOP LWT 35°C/ 55°C	W/W	4.42/ 3.01	4.65/ 2.92	
		Seasonal space heating enr. efficiency η _s LWT 35°C/ 55°C	ETA%	174/ 117	183/ 114	
		Average Seasonal space heating eff. class ** LWT 35°C/ 55°C	-	A++ / A+	A++ / A+	
		Current	MCA	A	22.00	28.00
			MFA	A	27.50	35.00
		Maximum allowable IDU ⁵ connections (Hydro A2Wunit not included)	Max. number of IDU ⁵	EA	4	5
	Total capacity Min. (Cooling)		kW	4.50	6.00	
	Leaving Water Temperature ³	Total capacity Min. (Cooling)	kW	9.00	12.10	
		Heating	°C	15-55	15-55	
	Functions	Cooling	°C	5-25	5-25	
		Smart Grid Ready / PV Enabled	-	•	•	
		3-Step Quiet Mode	-	•	•	
	2-zone Control	-	•	•		
Tank Integrated Hydro Unit	Power Supply		Φ, #, V, Hz	1Φ, 2, 220-240 V, 50 Hz	1Φ, 2, 220-240 V, 50 Hz	
	Water Tank Volume		litres	260	260	
	Declared Load Profile		L/XL	XL	XL	
	Average water heating efficiency η _{wh}		ETA%	105	95	
	Average Energy Efficiency Class		-	A	A	
	Heater	Back-up heater Capacity	Default (Option)	kW	2 (4/6)	2 (4/6)
	Sound	Sound Pressure ⁴	Heating Std	dB(A)	29	29
			Cooling Std	dB(A)	29	29
	Sound Power	Heating Std		dB(A)	43	47
Piping	Water pipe (Space Heating)	Inlet/Outlet	Φ, inch	1+1/4"	1+1/4"	
Dimensions	Net Weight		kg	147	147	
	Net Dimensions (WxHxD)		mm	595 x 1,800 x 700	595 x 1,800 x 700	
Outdoor Unit	Power Supply		Φ, V, Hz	1Φ, 2, 220-240 V, 50 Hz	1Φ, 2, 220-240 V, 50 Hz	
	Compressor	Type	-	Rotary Comp	Rotary Comp	
	Base Heater	Capacity		kW	-	-
	Sound	Sound Pressure ⁴	Heating Std	dB(A)	51	52
			Cooling Std	dB(A)	50	51
		Sound Power	Heating Std	dB(A)	69	70
	Dimensions	Net Weight		kg	74.0	107.0
		Net Dimensions (WxHxD)		mm	940 x 998 x 330	940 x 1,420 x 330
	Refrigerant	Type		Type	R410A (Fluorinated greenhouse gas, GWP=2,088)	R410A (Fluorinated greenhouse gas, GWP=2,088)
		Factory Charging		tCO ₂ e	5.01	7.31
				kg	2.4	3.5
	Piping	Piping Connections	Liquid Pipe	Φ, mm (inch)	9.52 (3/8")	9.52 (3/8")
			Gas Pipe	Φ, mm (inch)	15.88 (5/8")	15.88 (5/8")
		Piping length (ODU-IDU) ⁵	Max.[Equiv.]	m	30	70
		Level difference (IDU-IDU) ⁵	Max.	m	20	30
		Chargeless length		m	10	10
	Operation	Ambient Temperature A2W	Heating	°C	-25-35	-25-35
			Cooling	°C	10-46	10-46
			DHW	°C	-25-43	-25-43
		Ambient Temperature A2A	Heating	°C	-25-24	-25-24
Cooling			°C	10-46	10-46	

Accessories



Touch Controller	Touch Controller	DMS2.5	Wi-Fi Kit	External Room Sensor	Backup Heater (4/6kW)
MWR-WW10N	MCM-A300N	MIM-D01AN	MIM-H04EN	MRW-TA	MHC-*00FE



AE260TNWTEH/EU AE160MXTPEH/EU MWR-WW10N	AE260TNWTEH/EU AE090MXTPGH/EU MWR-WW10N	AE260TNWTEH/EU AE120MXTPGH/EU MWR-WW10N	AE260TNWTEH/EU AE160MXTPGH/EU MWR-WW10N
16.0/14.6	9.0/7.7	12.0/10.7	16.0/14.6
14.5	8.0	12.0	14.5
3.95/ 5.32	2.12/ 2.82	2.72/ 3.91	3.95/ 5.32
3.84	1.86	2.90	3.84
4.05/2.74	4.25/2.69	4.41/ 2.74	4.05/2.74
3.78	4.30	4.14	3.78
4.63/3.06	4.44/2.86	4.65/2.92	4.63/ 3.06
182/119	175/111	183/114	182/119
A+++ / A+	A+++ / A+	A+++ / A+	A+++ / A+
32.00	10.00	10.00	12.00
40.00	16.10	16.10	16.10
7	4	5	7
7.70	4.50	6.00	7.70
15.40	9.00	12.10	15.40
15-55	15-55	15-55	15-55
5-25	5-25	5-25	5-25
•	•	•	•
•	•	•	•
•	•	•	•
1φ, 2, 220-240 V, 50 Hz	1φ, 2, 220-240 V, 50 Hz	1φ, 2, 220-240 V, 50 Hz	1φ, 2, 220-240 V, 50 Hz
260	260	260	260
XL	XL	XL	XL
95	105	95	95
A	A	A	A
2 (4/6)	2 (4/6)	2 (4/6)	2 (4/6)
29	29	29	29
29	29	29	29
47	43	47	47
1+1/4"	1+1/4"	1+1/4"	1+1/4"
147	147	147	147
595 x 1,800 x 700	595 x 1,800 x 700	595 x 1,800 x 700	595 x 1,800 x 700
1φ, 2, 220-240 V, 50 Hz	3φ, 4, 380-415 V, 50 Hz	3φ, 4, 380-415 V, 50 Hz	3φ, 4, 380-415 V, 50 Hz
Rotary Comp	Rotary Comp	Rotary Comp	Rotary Comp
-	-	-	-
55	51	52	55
54	50	51	54
73	69	70	73
107.0	76.0	107.0	107.0
940 x 1,420 x 330	940 x 998 x 330	940 x 1,420 x 330	940 x 1,420 x 330
R410A (Fluorinated greenhouse gas, GWP=2,088)			
7.31	5.01	7.31	7.31
3.5	2.4	3.5	3.5
9.52 (3/8")	9.52 (3/8")	9.52 (3/8")	9.52 (3/8")
15.88 (5/8")	15.88 (5/8")	15.88 (5/8")	15.88 (5/8")
70	30	70	70
30	20	30	30
10	10	10	10
-25-35	-25-35	-25-35	-25-35
10-46	10-46	10-46	10-46
-25-43	-25-43	-25-43	-25-43
-25-24	-25-24	-25-24	-25-24
10-46	10-46	10-46	10-46



³35dB(A) is only applicable for 6kW and 9kW outdoor units down to +4°C stated in 3 m distance in an anechoic environment.

^{**}A+++ energy label is available according to EU No. 811/2013 label classification 2019, on a scale from D to A+++

¹A2W Condition : (Heating) Water In/Out 30°C/35°C, Outdoor Air 7°C[DB]/6°C[WB]; (Cooling) Water In/Out 23°C/18°C, Outdoor Air 35°C[DB].

²A2W Condition : (Heating) Water In/Out 47°C/55°C, Outdoor Air 7°C[DB]/6°C[WB].

³65°C down to +10°C (max. 60°C down to -5°C)

⁴Sound pressure level is obtained in an anechoic room. Sound pressure level is a relative value, depending on the distance and acoustic environment. Sound pressure level may differ depending on operation conditions.

⁵ODU : Outdoor Unit, IDU : Indoor Unit

Specifications

TDM Plus with Third party tank connection (R410A)

- 'All in one' air-to-water and air-to-air system
- Connectable with R410A Split ODU in combination of third party Tank
- Compatible with room thermostats, solar pumps, 2- or 3-way valves and back-up boilers



		Indoor Unit		AE090MNYDEH/EU	AE090MNYDEH/EU	AE090MNYDEH/EU	AE090MNYDGH/EU	
		Outdoor Unit		AE044MXTPEH/EU	AE066MXTPEH/EU	AE090MXTPEH/EU	AE090MXTPGH/EU	
System	Operation	Nominal Capacity	Heating A7/W35 ¹ / A7/W55 ²	kW	4.4/ 3.8	6.6/ 4.8	9.0/ 7.7	9.0/ 7.7
			Cooling A35/W18 ¹	kW	5.1	6.7	8.0	8.0
		Power Input (Nominal)	Heating A7/W35 ¹ / A7/W55 ²	kW	0.93/1.37	1.47/1.85	2.12/ 2.82	2.12/ 2.82
			Cooling A35/W18 ¹	kW	1.03	1.48	1.85	1.86
		COP (Nominal Heating) A7/W35 ¹	W/W	4.73/2.80	4.49/2.59	4.25/2.72	4.25/2.69	
		EER (Nominal Cooling) A35/W18 ¹	W/W	4.95	4.53	4.32	4.30	
		SCOP LWT 35°C/ 55°C	W/W	4.41/ 2.83	4.41/2.96	4.42/ 3.01	4.44/ 2.86	
		Seasonal space heating enr. efficiency η _s LWT 35°C/ 55°C	ETA%	173/ 110	173/ 115	174/ 117	175/ 111	
		Seasonal Space Heating Eff. Class LWT 35°C/ 55°C			A++ / A+	A++ / A+	A++ / A+	A+++ / A+
		Current	MCA	A	18	20	22	10
	MFA		A	25.0	25.0	27.5	16.1	
	Maximum Allowable IDU ⁶ Connections (Hydro A2W Unit Not included)	Max. Number of IDU ⁶	EA	2	3	4	4	
		Total Capacity Min. (Cooling)	kW	2.2	3.3	4.5	4.5	
		Total Capacity Min. (Cooling)	kW	4.4	6.6	9.0	9.0	
	Leaving Water Temperature ³	Heating	°C	15-55 (H/P: 25-55)	15-55 (H/P: 25-55)	15-55 (H/P: 25-55)	15-55 (H/P: 25-55)	
		Cooling	°C	5-25	5-25	5-25	5-25	
	Functions	Smart Grid Ready/ PV Enabled	-	-	-	-	-	
3-Step Quiet Mode		-	•	•	•	•		
2-zone Control ⁴		-	•	•	•	•		
Wall-Mounted Hydro Unit	Power Supply		Φ, #, V, Hz	1Φ, 2, 220-240 V, 50 Hz	1Φ, 2, 220-240 V, 50 Hz	1Φ, 2, 220-240 V, 50 Hz	3Φ, 4, 380-415 V, 50 Hz	
	Expansion Vessel		litres	8	8	8	8	
	Heater	Back-up heater Capacity	kW	4	4	4	6	
	Sound	Sound Pressure ⁵	Std	dB(A)	31	31	31	31
		Sound Power	Std	dB(A)	48	48	48	48
	Piping	Water pipe	Inlet/Outlet	Φ, inch	1+1/4"	1+1/4"	1+1/4"	1+1/4"
	Dimensions	Net Weight		kg	45.5	45.5	45.5	46.5
Net Dimensions (WxHxD)			mm	510 x 850 x 315	510 x 850 x 315	510 x 850 x 315	510 x 850 x 315	
Outdoor Unit	Power Supply		Φ, V, Hz	1Φ, 2, 220-240 V, 50 Hz	1Φ, 2, 220-240 V, 50 Hz	1Φ, 2, 220-240 V, 50 Hz	3Φ, 4, 380-415 V, 50 Hz	
	Compressor	Type	-	Rotary Comp	Rotary Comp	Rotary Comp	Rotary Comp	
	Base Heater	Capacity	kW	-	-	-	-	
	Sound	Sound Pressure ⁵	Heating Std	dB(A)	47	48	51	51
			Cooling Std	dB(A)	46	47	50	50
		Sound Power	Heating Std	dB(A)	65	67	69	69
	Dimensions	Net Weight		kg	61	61	74	76
		Net Dimensions (WxHxD)		mm	880 x 793 x 310	880 x 793 x 310	940 x 998 x 330	940 x 998 x 330
	Refrigerant	Type		-	R410A (Fluorinated greenhouse gas, GWP=2,088)			
		Factory Charging		tCO ₂ e	5.43	5.43	5.01	5.01
				kg	2.6	2.6	2.4	2.4
	Piping	Piping Connections	Liquid Pipe	Φ, mm (inch)	9.52 (3/8")	9.52 (3/8")	9.52 (3/8")	9.52 (3/8")
			Gas Pipe	Φ, mm (inch)	15.88 (5/8")	15.88 (5/8")	15.88 (5/8")	15.88 (5/8")
		Piping Length (ODU-IDU) ⁵	Max. [Equiv.]	m	30	30	30	30
		Level Difference (IDU-IDU) ⁵	Max.	m	20	20	20	20
Chargeless Length			m	10	10	10	10	
Operation	Ambient Temperature A2W	Heating	°C	-25-35	-25-35	-25-35	-25-35	
		Cooling	°C	10-46	10-46	10-46	10-46	
		DHW	°C	-25-43	-25-43	-25-43	-25-43	
	Ambient Temperature A2A	Heating	°C	-25-24	-25-24	-25-24	-25-24	
		Cooling	°C	10-46	10-46	10-46	10-46	

Accessories



EHS Controller (included)	Touch Controller	DMS2.5	Wi-Fi Kit	External Room Sensor
MWR-WW00N	MCM-A300N	MIM-D01AN	MIM-H04EN	MRW-TA



AE160MNYDEH/EU AE120MXTPEH/EU	AE160MNYDGH/EU AE120MXTPGH/EU	AE160MNYDEH/EU AE160MXTPEH/EU	AE160MNYDGH/EU AE160MXTPGH/EU
12.0/10.7	12.0/10.7	16.0/14.6	16.0/14.6
12.0	12.0	14.5	14.5
2.72/ 3.91	2.72/ 3.91	3.95/ 5.32	3.95/ 5.32
2.90	2.90	3.84	3.84
4.41/2.74	4.41/2.74	4.05/2.74	4.05/2.74
4.14	4.14	3.78	3.78
4.65/ 2.92	4.65/ 2.92	4.63/ 3.06	4.63/ 3.06
183/114	183/114	182/119	182/119
28	10	32	12
35.0	16.1	40.0	16.1
5	5	7	7
6.0	6.0	7.7	7.7
12.1	12.1	15.4	15.4
15-55 (H/P : 25-55)	15-55 (H/P : 25-55)	15-55 (H/P : 25-55)	15-55 (H/P : 25-55)
5-25	5-25	5-25	5-25
-	-	-	-
•	•	•	•
•	•	•	•
1Φ, 2, 220-240 V, 50 Hz	3Φ, 4, 380-415 V, 50 Hz	1Φ, 2, 220-240 V, 50 Hz	3Φ, 4, 380-415 V, 50 Hz
8	8	8	8
6	6	6	6
38	38	38	38
55	55	55	55
1+1/4"	1+1/4"	1+1/4"	1+1/4"
46.5	46.5	46.5	46.5
510 x 850 x 315	510 x 850 x 315	510 x 850 x 315	510 x 850 x 315
1Φ, 2, 220-240 V, 50 Hz	3Φ, 4, 380-415 V, 50 Hz	1Φ, 2, 220-240 V, 50 Hz	3Φ, 4, 380-415 V, 50 Hz
Rotary Comp	Rotary Comp	Rotary Comp	Rotary Comp
-	-	-	-
52	52	55	55
51	51	54	54
70	70	73	73
107	107	107	107
940 x 1,420 x 330	940 x 1,420 x 330	940 x 1,420 x 330	940 x 1,420 x 330
	R410A (Fluorinated greenhouse gas, GWP=2,088)		
7.31	7.31	7.31	7.31
3.5	3.5	3.5	3.5
9.52 (3/8")	9.52 (3/8")	9.52 (3/8")	9.52 (3/8")
15.88 (5/8")	15.88 (5/8")	15.88 (5/8")	15.88 (5/8")
70	70	70	70
30	30	30	30
10	10	10	10
-25-35	-25-35	-25-35	-25-35
10-46	10-46	10-46	10-46
-25-43	-25-43	-25-43	-25-43
-25-24	-25-24	-25-24	-25-24
10-46	10-46	10-46	10-46



*35dB(A) is only applicable for 6kW and 9kW outdoor units down to +4°C stated in 3 m distance in an anechoic environment.

**A+++ energy label is available according to EU No. 811/2013 label classification 2019, on a scale from D to A+++

¹A2W Condition : (Heating) Water In/Out 30°C/35°C, Outdoor Air 7°C[DB]/6°C[WB]; (Cooling) Water In/Out 23°C/18°C, Outdoor Air 35°C[DB].

²A2W Condition : (Heating) Water In/Out 47°C/55°C, Outdoor Air 7°C[DB]/6°C[WB].

³65°C down to +10°C (max. 60°C down to -5°C)

⁴Not provided by Samsung.

⁵Sound pressure level is obtained in an anechoic room. Sound pressure level is a relative value, depending on the distance and acoustic environment. Sound pressure level may differ depending on operation conditions.

⁶ODU : Outdoor Unit, IDU : Indoor Unit

Specifications

TDM Plus WindFree™ Deluxe

- Three-step cooling: Fast Cooling mode
- WindFree™ Cooling Mode
- Wi-Fi Control with SmartThings and Bixby voice controls
- Equipped with NASA communication protocol
- Equipped with Easy Filter Plus



Type			TDM Plus WindFree™ Deluxe	TDM Plus WindFree™ Deluxe	TDM Plus WindFree™ Deluxe
Model Name			AE022TNXDEH/EU	AE028TNXDEH/EU	AE036TNXDEH/EU
Power Supply		Φ, #, V, Hz	1Φ, 2, 220~240 V, 50 Hz	1Φ, 2, 220~240 V, 50 Hz	1Φ, 2, 220~240 V, 50 Hz
Capacity	Cooling	kW	2.20	2.80	3.60
	Heating	kW	2.50	3.20	4.00
Power Input (Nominal)	Cooling	W	24.0	30.0	37.0
	Heating	W	24.0	30.0	37.0
Current Input (Nominal)	Cooling	A	0.16	0.20	0.25
	Heating	A	0.16	0.20	0.25
Fan	Type	-	Cross flow Fan	Cross flow Fan	Cross flow Fan
	Quantity	EA	1	1	1
	Air Flow Rate H/M/L	m ³ /min	5.7/5.0/4.5	8.5/7.7/6.9	10.3/9.1/8.3
		l/s	95.0/83.3/75.0	141.7/128.3/115.0	171.7/151.7/138.3
Fan motor	Type	-	BLDC	BLDC	BLDC
	Output xn	W	27x1	27x1	27x1
Piping Connections	Liquid Pipe	Φ, mm(inch)	6.35 (1/4")	6.35 (1/4")	6.35 (1/4")
	Gas Pipe	Φ, mm(inch)	12.7 (1/2")	12.7 (1/2")	12.7 (1/2")
Wiring connections	For power supply below 20m/over 20m (min)	mm ²	1.5/2.5	1.5/2.5	1.5/2.5
	Communication (min)	mm ²	0.75	0.75	0.75
Refrigerant	Type	-	R410A (Fluorinated greenhouse gas, GWP=2,088)		
	Control Method ¹	-	EEV NOT INCLUDED	EEV NOT INCLUDED	EEV NOT INCLUDED
Sound	Sound Pressure H/M/L/WF ²	dB(A)	34/32/30/27	34/33/32/26	40/36/34/26
	Sound Power	dB(A)	51	52	56
Dimensions	Net Weight	kg	8.50	9.00	9.00
	Net Dimensions (WxHxD)	mm	820 x 299 x 215	820 x 299 x 215	820 x 299 x 215
Functions					
Air Flow	WindFree™ Cooling		•	•	•
	Air Direction Control (Up/Down)		Auto	Auto	Auto
	Air Direction Control (Left/Right)		Auto	Auto	Auto
Air Purification	Auto Fan speed		•	•	•
	Tri-Care Filter		-	-	-
	Easy Filter Plus		•	•	•
	Auto Clean (Self Cleaning)		•	•	•
Operating Mode	2 Step Cooling		•	•	•
	AI Auto Comfort with Wi-Fi & MDS (direct/indirect)		-	-	-
	AI Auto Comfort with Wi-Fi		-	-	-
	Auto Mode (without Wi-Fi)		-	-	-
	Fast Cooling		•	•	•
	Good Sleep		•	•	•
	Eco		•	•	•
	Dehumidification		•	•	•
	Fan		•	•	•
	Quiet		•	•	•
Other Functions	Samsung SmartThings		•	•	•
	MDS (Motion Detect Sensor)		-	-	-
	Indoor Temp. Display		•	•	•
	Display On/Off	88 Display	•	•	•
	Beep On/Off		•	•	•
	Auto Changeover		•	•	•
	Auto Restart		•	•	•

Accessories



1-room EEV Kit	2/3 Room EEV Kit	Wireless Remote Controller (included)	Touch Controller	Wired Remote Controller	DMS2.5	Wi-Fi Kit
MEV-E**SA	MXD-E**K***A	AR-EH03E	MWR-SH11N	MWR-WE13N	MIM-D01AN	MIM-H04EN



TDM Plus WindFree™ Deluxe AE056TNXDEH/EU	TDM Plus WindFree™ Deluxe AE071TNXDEH/EU
1Φ, 2, 220–240 V, 50 Hz	1Φ, 2, 220–240 V, 50 Hz
5.60	6.80
6.30	7.00
52.0	60.0
52.0	60.0
0.35	0.40
0.35	0.40
Cross flow Fan	Cross flow Fan
1	1
15.7/13.8/12.0	16.8/15.0/13.2
261.7/230.0/200.0	280.0/250.0/220.0
BLDC	BLDC
27x1	27x1
6.35 (1/4")	9.52 (3/8")
12.7 (1/2")	15.88 (5/8")
1.5/2.5	1.5/2.5
0.75	0.75
R410A (Fluorinated greenhouse gas, GWP=2,088)	
EEV NOT INCLUDED	EEV NOT INCLUDED
40/37/34/29	43/40/37/29
58	62
11.50	11.50
1,055 x 299 x 215	1,055 x 299 x 215
•	•
Auto	Auto
Auto	Auto
•	•
-	-
•	•
•	•
•	•
-	-
-	-
-	-
•	•
•	•
•	•
•	•
•	•
•	•
•	•
•	•
•	•
•	•
•	•
•	•
•	•
•	•
•	•

Capacities are based on (Equivalent refrigerant piping 7.5m, Level differences 0m)

Cooling : Indoor temperature 27°C DB, 19°C WB / Outdoor temperature 35°C DB, 24°C WB

Heating : Indoor temperature 20°C DB, 15°C WB / Outdoor temperature 7°C DB, 6°C WB

¹EEV Kit is necessary to control the refrigerant flow in the TDM Plus WindFree™ Deluxe (EEV Excluded), please order EEV Kit separately.

²Sound pressure level is obtained in an anechoic room. Sound pressure level is a relative value, depending on the distance and acoustic environment. Sound pressure level may differ depending on operation conditions.

Specifications

TDM Plus Slim Duct

- Slim design with thickness of just 199 mm
- Antibacterial filter included



Type			Slim Duct		Slim Duct		Slim Duct		Slim Duct	
Model Name			AE022MNLDEH/EU		AE028MNLDEH/EU		AE036MNLDEH/EU		AE056MNLDEH/EU	
Power Supply			Φ, #, V, Hz		1Φ, 2, 220-240 V, 50 Hz		1Φ, 2, 220-240 V, 50 Hz		1Φ, 2, 220-240 V, 50 Hz	
Performance	Capacity	Cooling / Heating	kW		2.2/2.5		2.8/3.2		3.6/4.0	
	Power Input	Cooling / Heating	W		55/55		60/60		65/65	
Power	Current Input	Cooling / Heating	A		0.30/0.30		0.32/0.32		0.33/0.33	
	Type		-		Sirocco Fan		Sirocco Fan		Sirocco Fan	
Fan	Quantity		EA		2		2		2	
	Air Flow Rate	H/M/L (UL)	m ³ /min		7.0 / 6.1 / 5.3		7.5 / 6.6 / 5.6		7.5 / 6.6 / 5.6	
	External Pressure	Max. (Min/Std/Max)	mmAq		0/1/3		0/1/3		0/1/3	
Pa			0/9.8/29.4		0/9.8/29.4		0/9.8/29.4			
Fan Motor	Type		-		SSR non-feedback		SSR non-feedback		SSR non-feedback	
	Output x n		W		28x1		28x1		28x1	
Piping Connections	Liquid Pipe		Φ, mm (inch)		6.35 (1/4")		6.35 (1/4")		6.35 (1/4")	
	Gas Pipe		Φ, mm (inch)		12.7 (1/2")		12.7 (1/2")		12.7 (1/2")	
Refrigerant	Type		-		R410A (Fluorinated greenhouse gas, GWP=2,088)					
Sound	Sound Pressure	H/M/L	dB(A)		26 / 24 / 21		28 / 26 / 23		32 / 30 / 27	
	Sound Power		dB(A)		49		49		51	
Dimensions	Net Weight		kg		19		19		19,5	
	Net Dimensions (W×H×D)		mm		700 x 199 x 600		700 x 199 x 600		700 x 199 x 600	
Optional Accessories	Drain Pump	Model	-		MDP-E075SEE3D (Built-in)		MDP-E075SEE3D (Built-in)		MDP-E075SEE3D (Built-in)	
		Max. lifting Height/ Displacement	mm / Litre/h		750 / 24		750 / 24		750 / 24	

Accessories



Drain Pump (Built-in)	Remote Control	Touch Controller	Wired Remote Control	Wireless Receiver Kit	Touch Controller	DMS2.5	Wi-Fi Kit	External Room Sensor	Y-joint
MDP-E075SEE3D	AR-EH00	MWR-SH11N	MWR-WE13N	MRK-A10N	MCM-A300N	MIM-D01AN	MIM-H04EN	MRW-TA	MXJ-YA1509M

Specifications

TDM Plus MSP Duct

- External static pressure range from 0 to 1.4 mmAq
- Built-in electronic expansion valve (EEV) for refrigerant flow control (2000 step)
- Long-life washable permanent filter is included
- Auto Restart function.
- Built-in condensation drain pump (750 mmH2O)
- SPI Ioniser device (optional)



Type			MSP Duct	MSP Duct
Model Name			AE071MNMPEH/EU	AE090MNMPEH/EU
Power Supply		Φ, #, V, Hz	1Φ, 2, 220-240 V, 50 Hz	1Φ, 2, 220-240 V, 50 Hz
Performance	Capacity	Cooling / Heating kW	7.1/8.0	9.0/10.0
Power	Power Input	Cooling / Heating W	120/120	145/145
	Current Input	Cooling / Heating A	1.0/1.0	1.2/1.2
Fan	Type	-	Sirocco Fan	Sirocco Fan
	Quantity	EA	2	2
	Air Flow Rate	H/M/L (UL) m³/min	22 / 19 / 16	29 / 25 / 22
	External Pressure	Max. (Min/Std/Max) mmAq Pa	0 / 3 / 15	0 / 4 / 15
0 / 29.4 / 147.2			0 / 29.4 / 147.2	
Fan Motor	Type	-	BLDC Feedback	BLDC Feedback
	Output x n	W	153x1	153x1
Piping Connections	Liquid Pipe	Φ, mm (inch)	9.52 (3/8")	9.52 (3/8")
	Gas Pipe	Φ, mm (inch)	15.88 (5/8")	15.88 (5/8")
Refrigerant	Type	-	R410A (Fluorinated greenhouse gas, GWP=2,088)	
Sound	Sound Pressure	H/M/L dB(A)	37 / 33 / 29	38 / 35 / 32
	Sound Power	dB(A)	57	58
Dimensions	Net Weight	kg	25,5	33
	Net Dimensions (W×H×D)	mm	850x250x700	1,200x250x700
Optional Accessories	Drain Pump	Model	MDP-G075SQ (Built-in)	MDP-G075SQ (Built-in)
			MDP-G075SP (External)	MDP-G075SP (External)
		Max. lifting Height/ Displacement mm / Litre/h	750 / 24	750 / 24

Accessories

Drain Pump (Built-in)	External Drain Pump	Remote Control	Touch Controller	Wired Remote Control	Touch Controller	DMS2.5	Wi-Fi Kit	External Room Sensor	Wireless Receiver Kit	Y-joint
MDP-G075SQ	MDP-G075SP	AR-EH00	MWR-SH11N	MWR-WE13N	MCM-A300N	MIM-D01AN	MIM-H04EN	MRW-TA	MRK-A10N	MXJ-YA1509M

Specifications

TDM Plus Console

- SPI Ioniser device (included)
- Slim design with 199mm in depth
- Built-in electronic expansion valve (EEV) for refrigerant flow control (2,000 step)
- Long-life washable permanent filter
- Auto Restart function
- Two separate air outlets, upper (cooling) and bottom (heating) to avoid stratifications



Type		Console		Console		Console		Console			
Model Name		AE022MNJDEH/EU		AE028MNJDEH/ EU		AE036MNJDEH/ EU		AE056MNJDEH/ EU			
Power Supply		Φ , #, V, Hz	1 Φ , 2, 220-240 V, 50 Hz		1 Φ , 2, 220-240 V, 50 Hz		1 Φ , 2, 220-240 V, 50 Hz		1 Φ , 2, 220-240 V, 50 Hz		
Performance	Capacity	Cooling / Heating	kW	2.2/2.5		2.8/3.2		3.6/4.0		5.6/6.3	
Power	Power Input	Cooling / Heating	W	16/16		30/30		35/35		62/62	
	Current Input	Cooling / Heating	A	0.13/0.13		0.25/0.25		0.29/0.29		0.49/0.49	
Fan	Type		-	Turbo Fan		Turbo Fan		Turbo Fan		Turbo Fan	
	Quantity		EA	1		1		1		1	
	Air Flow Rate	H/M/L (UL)	m ³ /min	6.3 / 5.4 / 4.9		7.0 / 6.0 / 5.0		8.50 / 7.50 / 6.50		13.0 / 11.5 / 10.0	
Piping Connections	Liquid Pipe		Φ , mm (inch)	6.35 (1/4")		6.35 (1/4")		6.35 (1/4")		6.35 (1/4")	
	Gas Pipe		Φ , mm (inch)	12.7 (1/2")		12.7 (1/2")		12.7 (1/2")		12.7 (1/2")	
Refrigerant	Type		-	R410A (Fluorinated greenhouse gas, GWP=2,088)							
Sound	Sound Pressure	H/M/L	dB(A)	34 / 32 / 30		38 / 36 / 34		39 / 37 / 34		43 / 40 / 37	
	Sound Power		dB(A)	52		58		59		64	
Dimensions	Net Weight		kg	15,5		16		16		16	
	Net Dimensions (W×H×D)		mm	720 x 620 x 199		720 x 620 x 199		720 x 620 x 199		720 x 620 x 199	

Accessories



Touch Controller	Remote Control (Included)	Touch Controller	DMS2.5	Wi-Fi Kit	External Room Sensor	Wired Remote Control	Y-joint
MWR-SH11N	MR-EH00	MCM-A300N	MIM-D01AN	MIM-H04EN	MRW-TA	MWR-WE13N	MXJ-YA1509M

Dimensional Drawings

TDM Plus Tank Integrated Hydro Unit

AE200TNWTEH/EU, AE260TNWTEH/EU

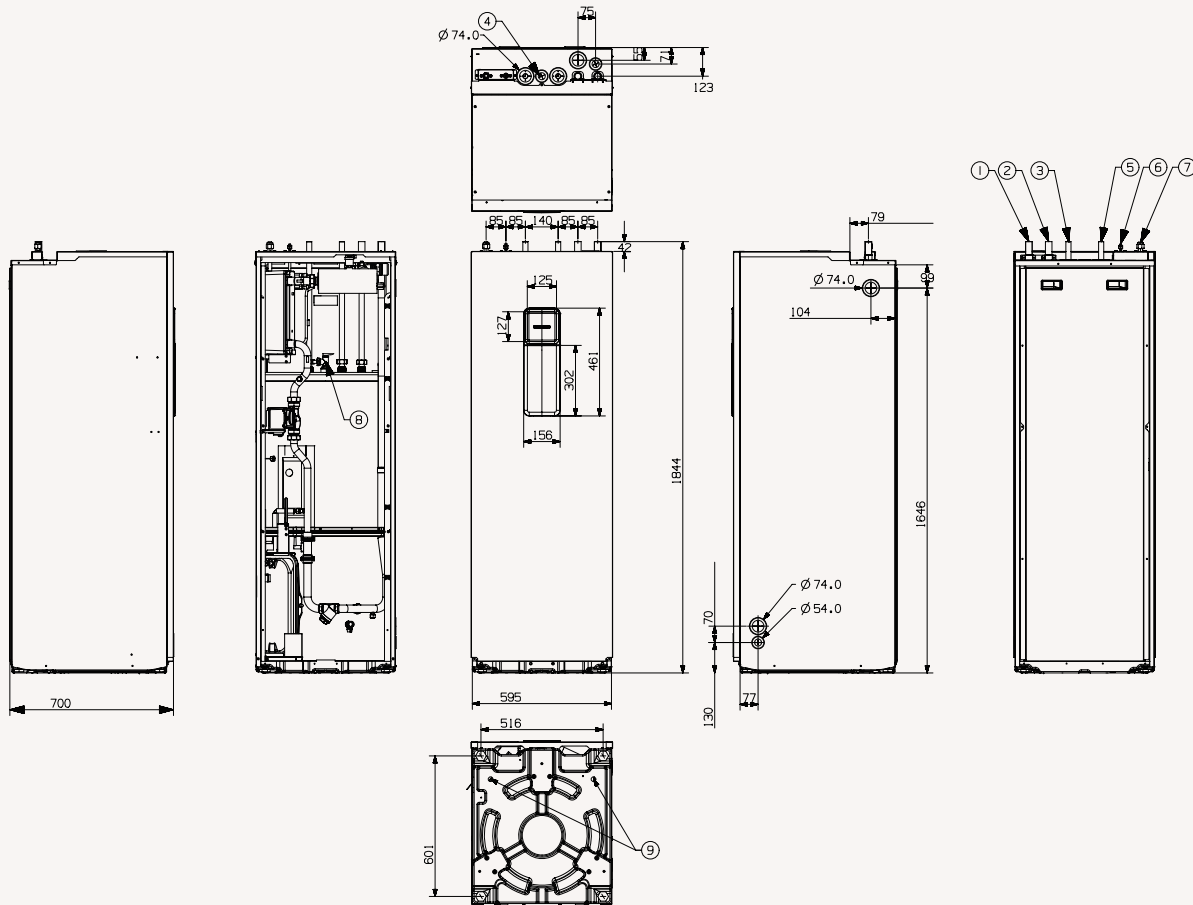

NO	Name	Description	
		AE200TNWTEH/EU	AE260TNWTEH/EU
1	Space heating Inlet	Ø28	Ø28
2	Space heating Outlet	Ø28	Ø28
3	DHW Inlet	Ø22	Ø22
4	Secondary water return	N/A	Ø22
5	DHW Outlet	Ø22	Ø22
6	Refrigerant liquid pipe	Ø9.52	Ø9.52
7	Refrigerant Gas pipe	Ø15.88	Ø15.88
8	T/Pv/v	Female PT1/2"	Female PT1/2"
9	Drain Holes	(Option) Connect with the provided drain plug	

Dimensional Drawings

TDM Plus Outdoor

AE044/066MXTPEH/EU

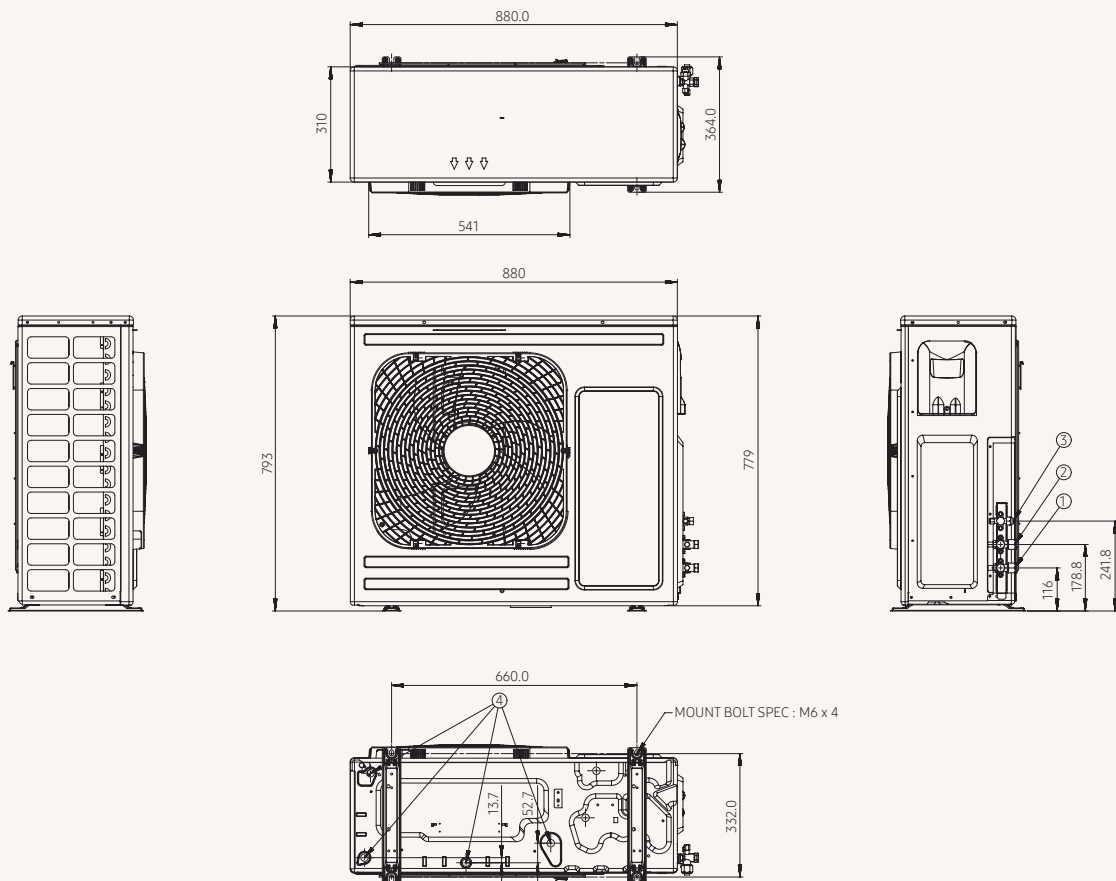

NO	Name	Description
		4.4 kW
		6.6 kW
1	Refrigerant gas pipe for air	Ø15.88("5/8)
2	Refrigerant gas pipe for water	Ø15.88("5/8)
3	Refrigerant liquid pipe	Ø9.52("3/8)
4	Drain holes	Connect with the provided drain plug.

TDM Plus Outdoor

AE090MXT*H/EU

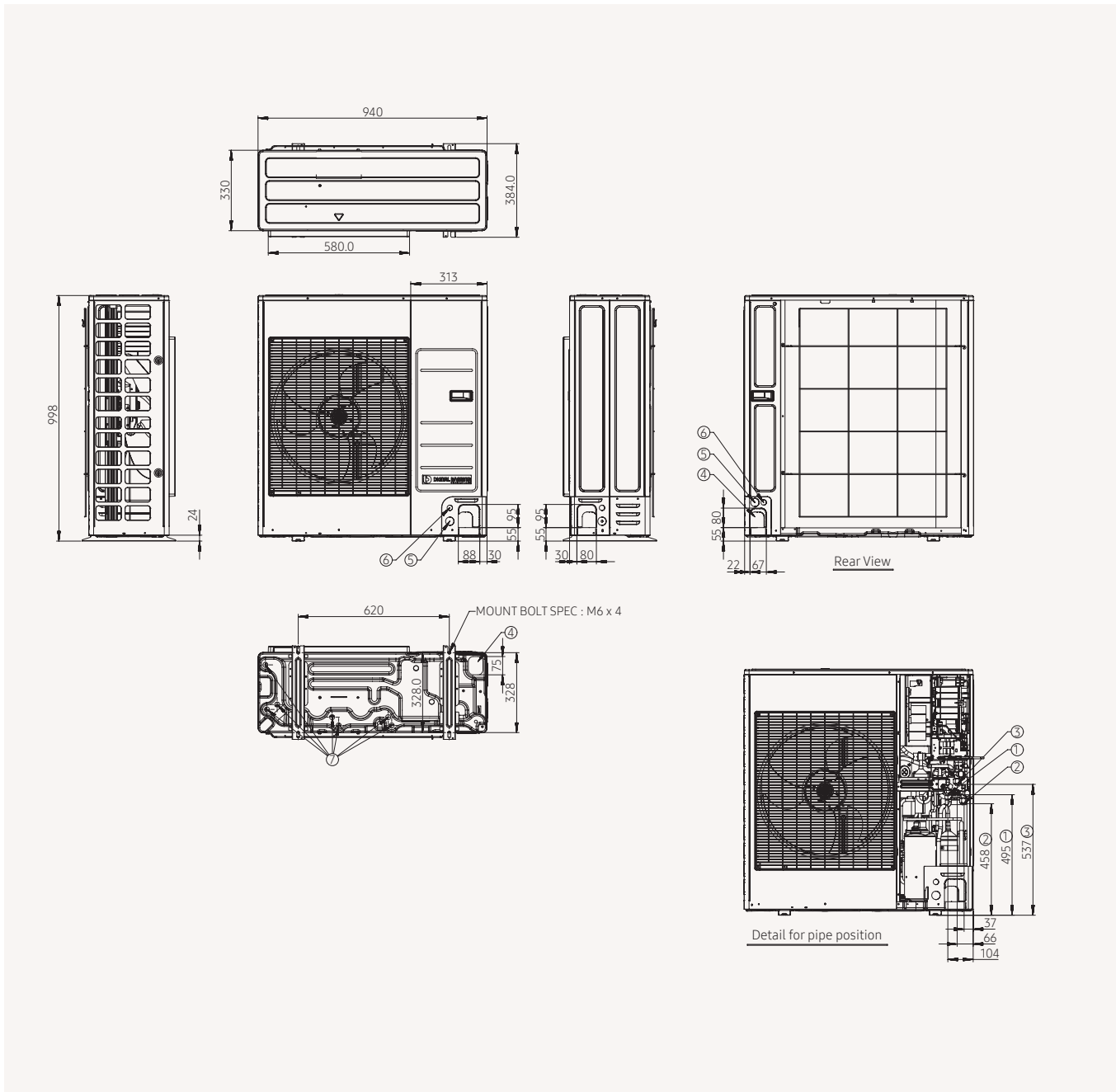

NO	Name	Description
		9 kW
1	Refrigerant liquid pipe	Φ9.52("3/8)
2	Refrigerant gas pipe for air	Φ15.88("5/8)
3	Refrigerant gas pipe for water	Φ15.88("5/8)
4	Knockout hole for pipe intake	Front / Side / Rear / Bottom
5	Power wiring conduits	Front / Side / Rear, Φ34("1-3/8)
6	Communication wiring conduits	Front / Side / Rear, Φ22("7/8)
7	Drain holes	Connect with the provided drain plug.

Dimensional Drawings

TDM Plus Outdoor

AE120/160MXP*H/EU

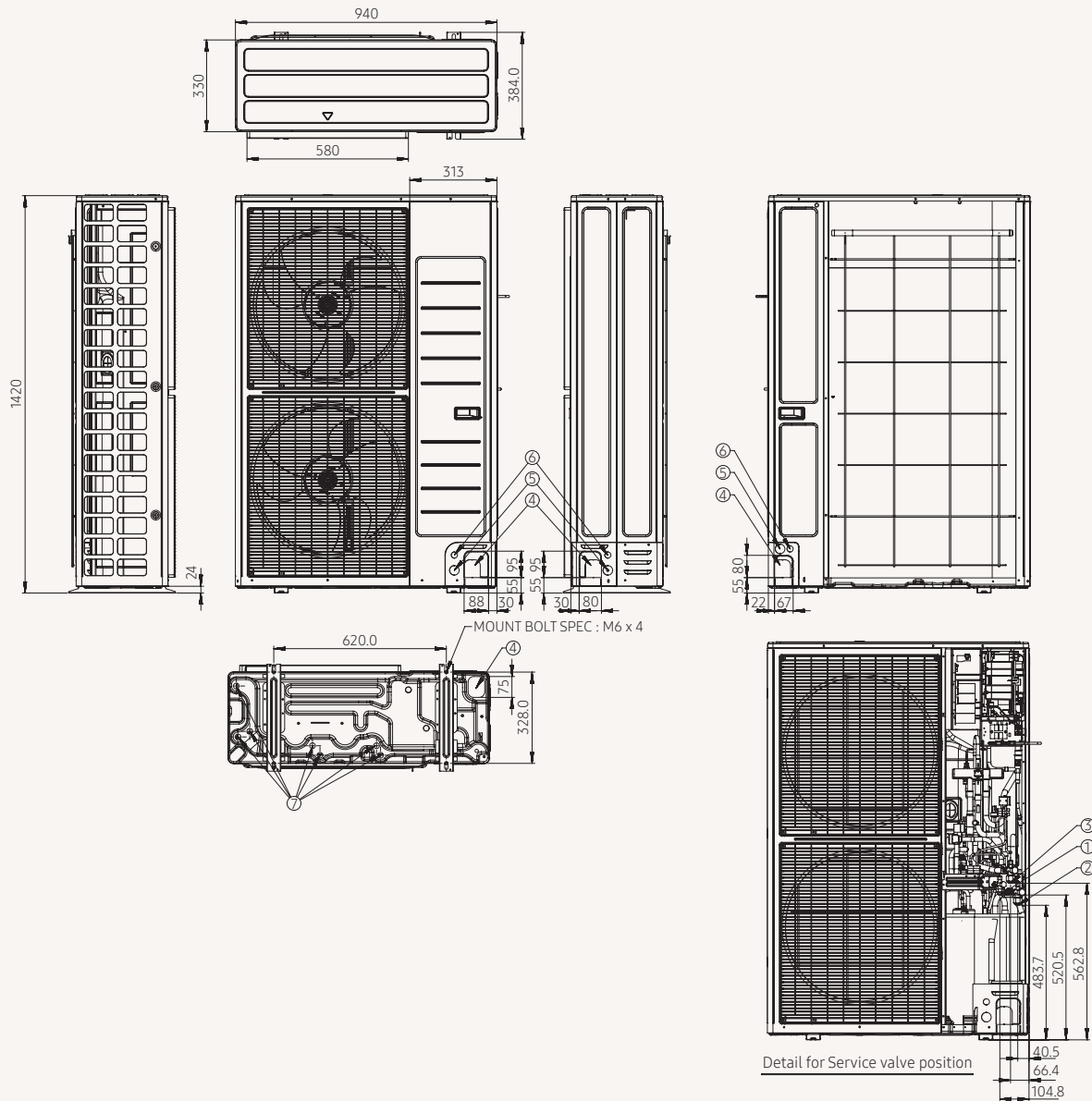

NO	Name	Description	
		12 kW	16 kW
1	Refrigerant liquid pipe	Φ9.52("3/8)	
2	Refrigerant gas pipe for air	Φ15.88("5/8)	Φ15.88("5/8)
3	Refrigerant gas pipe for water	Φ15.88("5/8)	Φ15.88("5/8)
4	Knockout hole for pipe intake	Front / Side / Rear / Bottom	Front / Side / Rear / Bottom
5	Power wiring conduits	Front / Side / Rear, Φ34("1-3/8)	Front / Side / Rear, Φ34("1-3/8)
6	Communication wiring conduits	Front / Side / Rear, Φ22("7/8)	Front / Side / Rear, Φ22("7/8)
7	Drain holes	Connect with the provided drain plug.	Connect with the provided drain plug.

WindFree™ Deluxe

AE022/028/036TNXDEH/EU

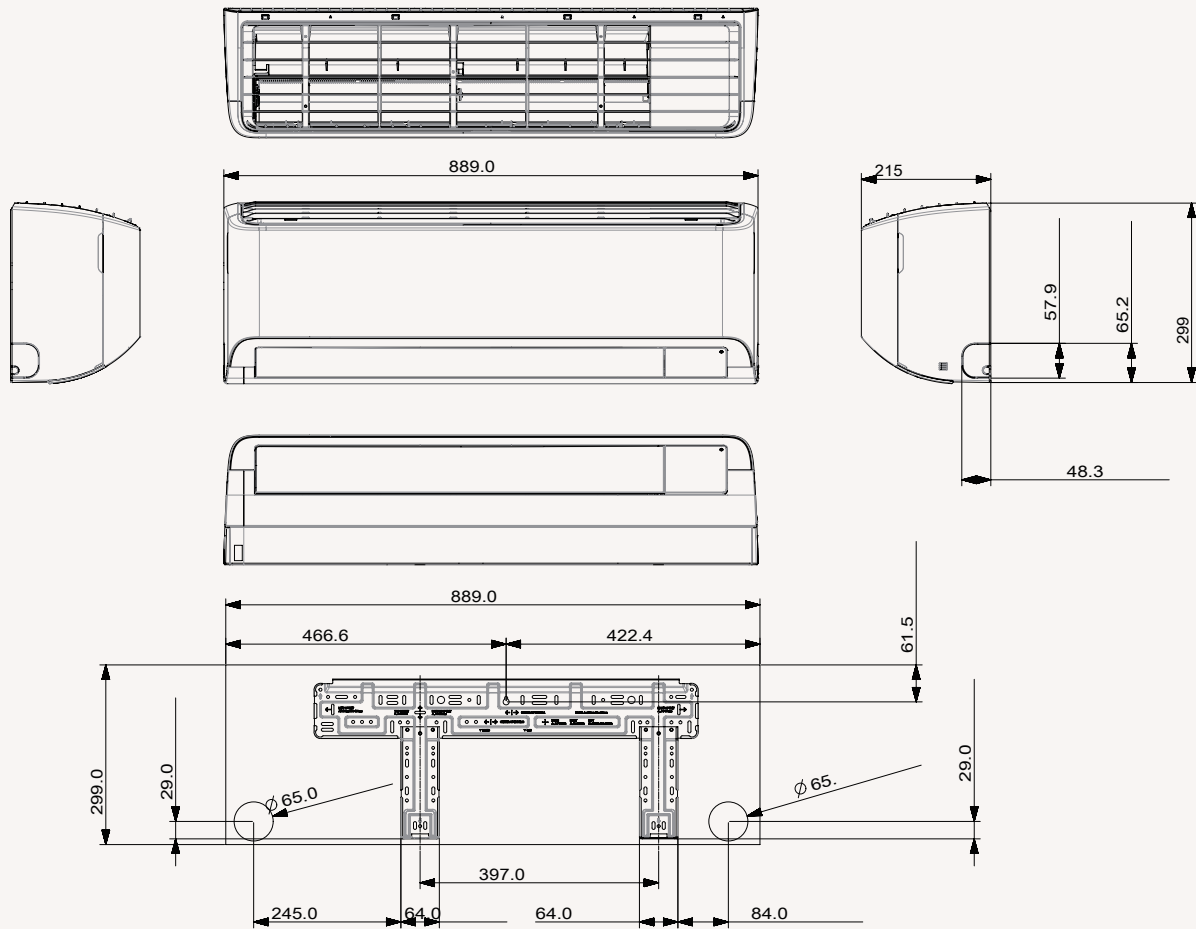

Dimensional Drawings

WindFree™ Deluxe

AE056/071TNXDEH/EU

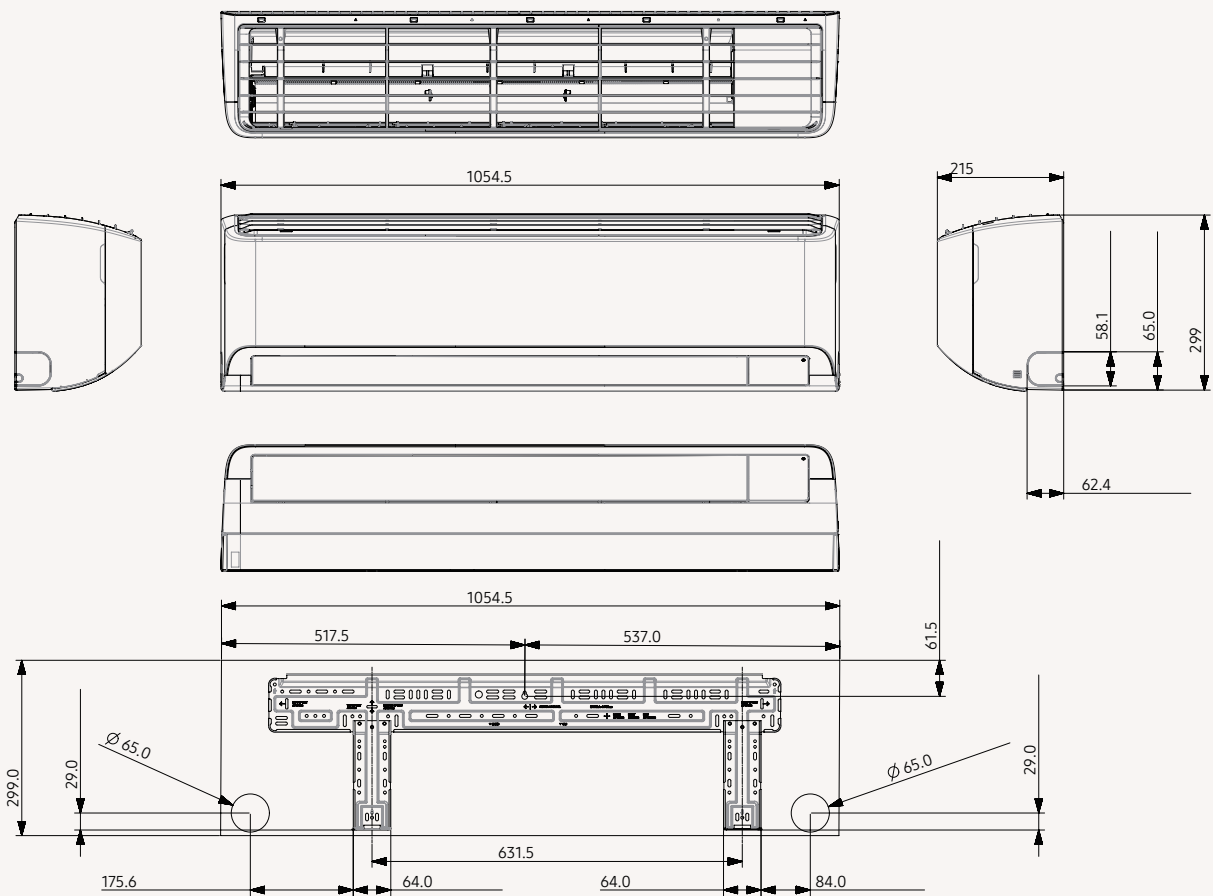

TDM Plus Slim Duct

AE022/028/036MNLDEH/EU

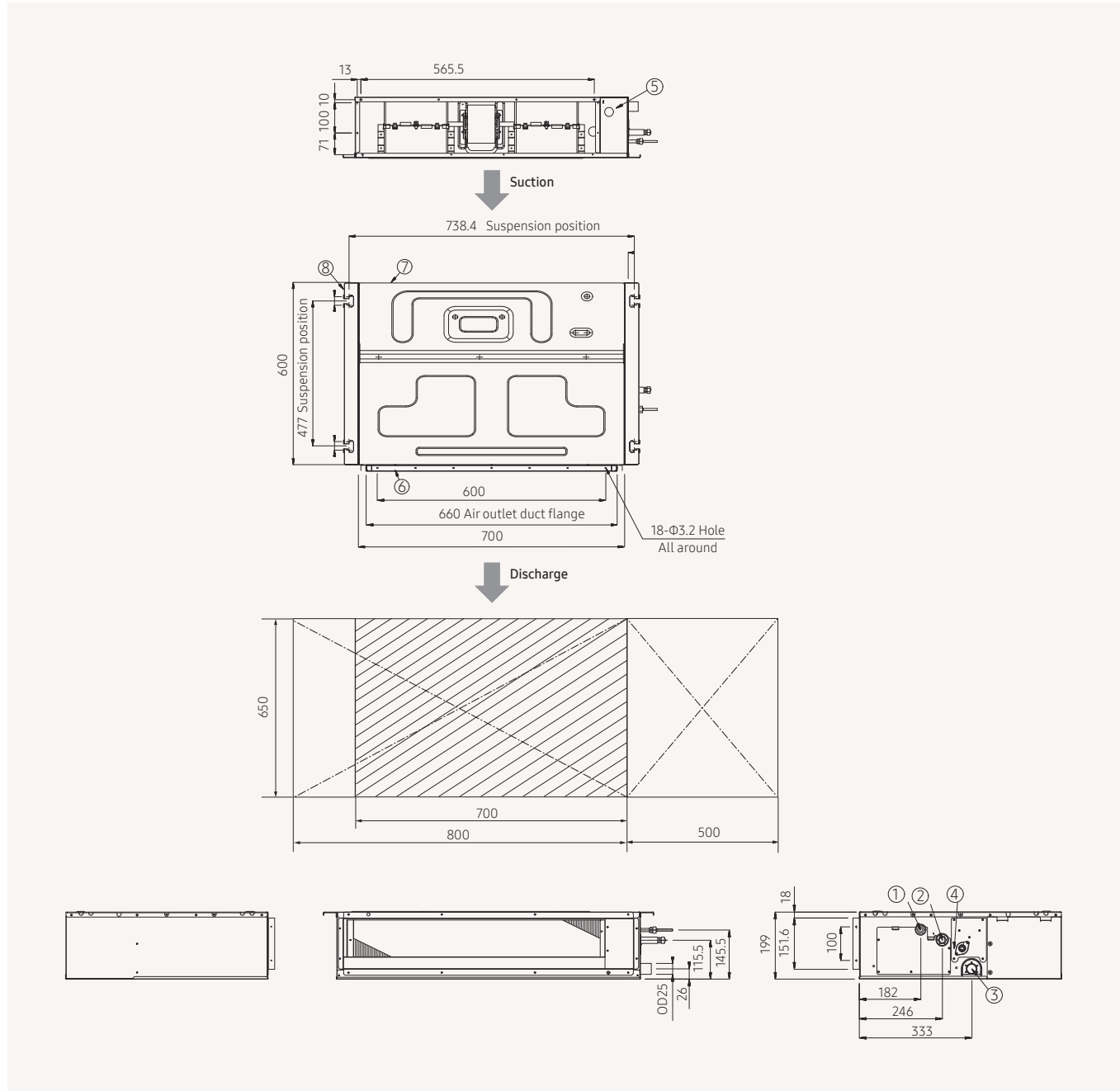

NO	Name	Description
1	Liquid pipe connection	Φ6.35(1/4")
2	Gas pipe connection	Φ12.70(1/2")
3	Drain pipe connection without drain pump	VP25(OD Φ32, ID Φ25)
4	Drain pipe connection with drain pump	VP25(OD Φ32, ID Φ25)
5	Power supply/Communication connection	-
6	Air discharge grille flange	-
7	Return air side	-
8	Hook	Φ9.52 or M10

Dimensional Drawings

TDM Plus MSP Duct

AE056MNLDEH/EU

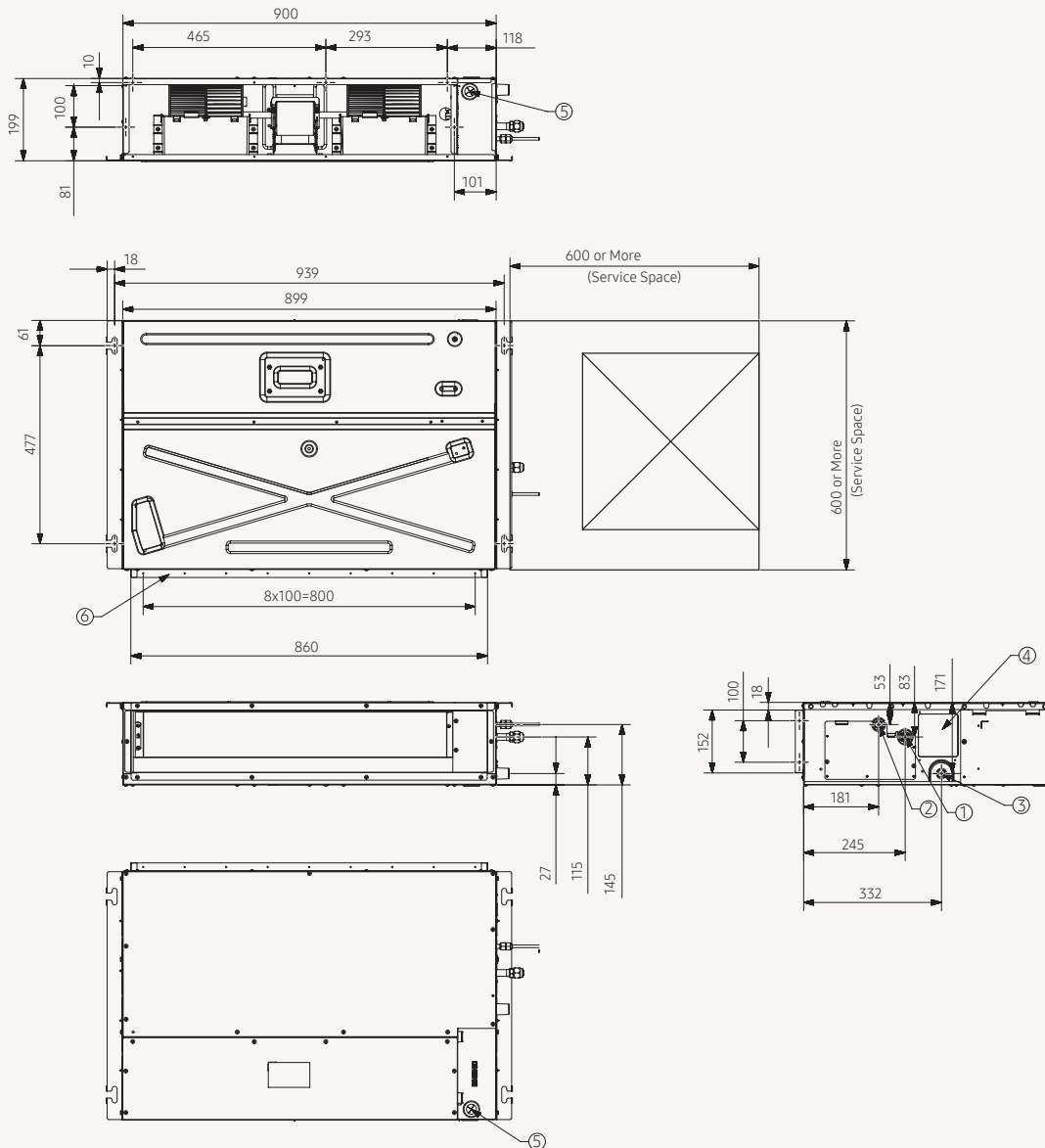

NO	Name	Description
1	Gas pipe connection	Φ12.7(1/2)
2	Liquid pipe connection	Φ6.35(1/4)
3	Drain pipe connection	VP-25(OD 32, ID 25)
4	Knockout hole for Drain pump	Option kit
5	Power supply & Communication wiring conduit	-
6	Air outlet duct flange	-

TDM Plus MSP Duct

AE071MNMPEH/EU

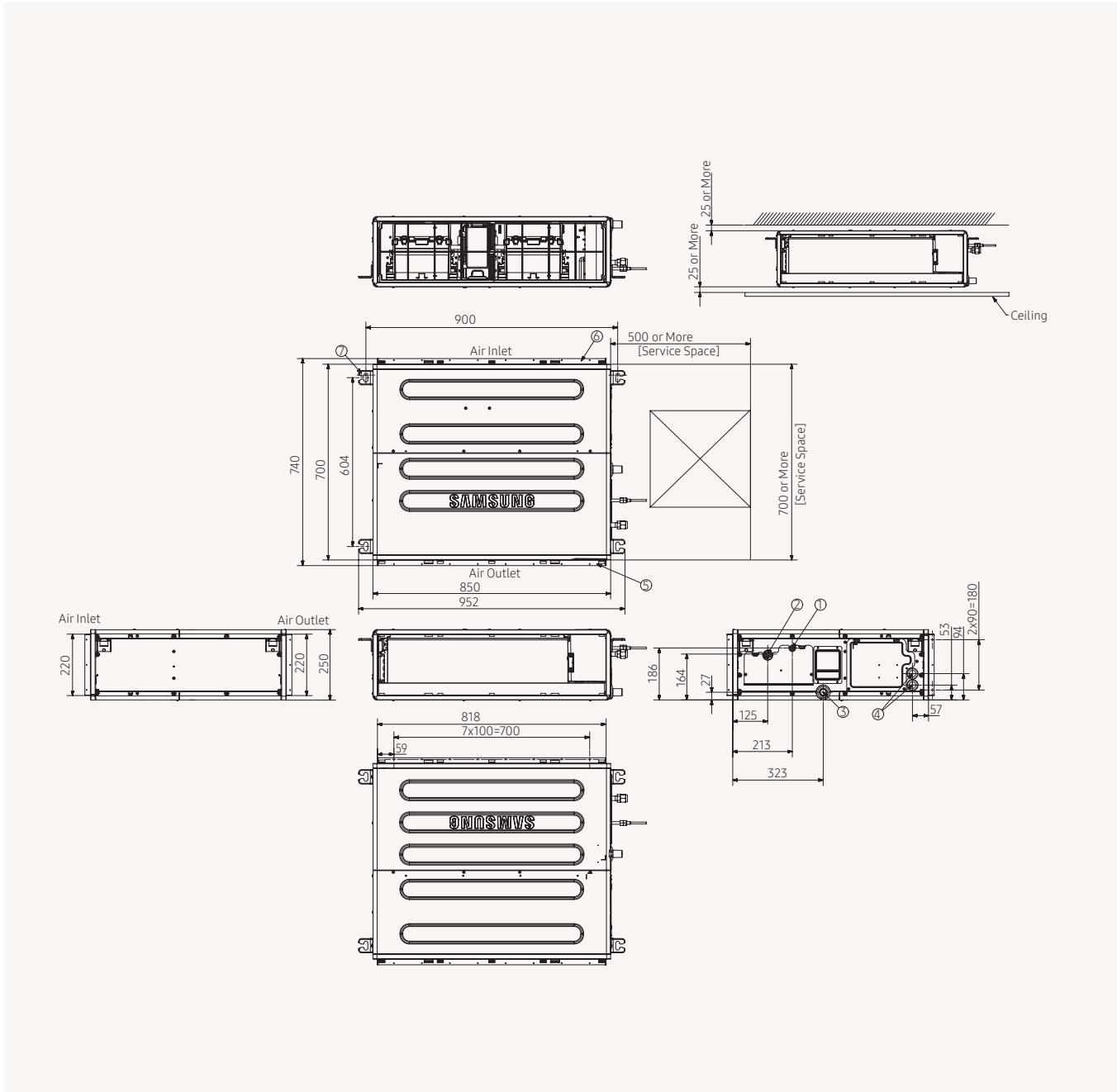

NO	Name	Description
1	Liquid pipe connection	Φ9.52(3/8)
2	Gas pipe connection	Φ15.88(5/8)
3	Drain pipe connection	VP-25(OD 32, ID 25)
4	Power supply & Communication wiring conduit	-
5	Air suction flange	-
6	Air discharge flange	-
7	Hook	Use M8-M10 bolt(4ea)

Dimensional Drawings

TDM Plus MSP Duct

AE090MMPEH/EU

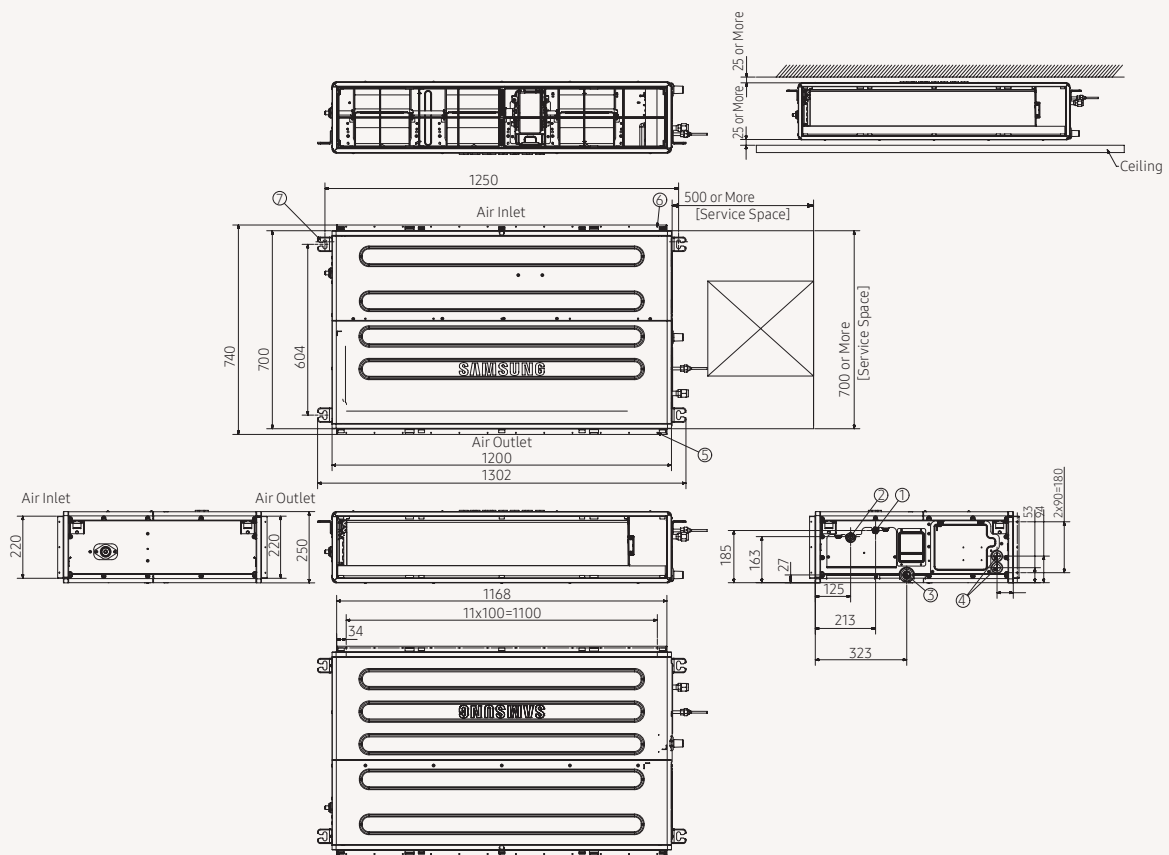

NO	Name	Description
1	Liquid pipe connection	Φ9.52(3/8)
2	Gas pipe connection	Φ15.88(5/8)
3	Drain pipe connection	VP-25(OD 32, ID 25)
4	Power supply & Communication wiring conduit	-
5	Air suction flange	-
6	Air discharge flange	-
7	Hook	Use M8-M10 bolt(4ea)

TDM Plus Console

AE022/028/036/056MNJDEH/EU

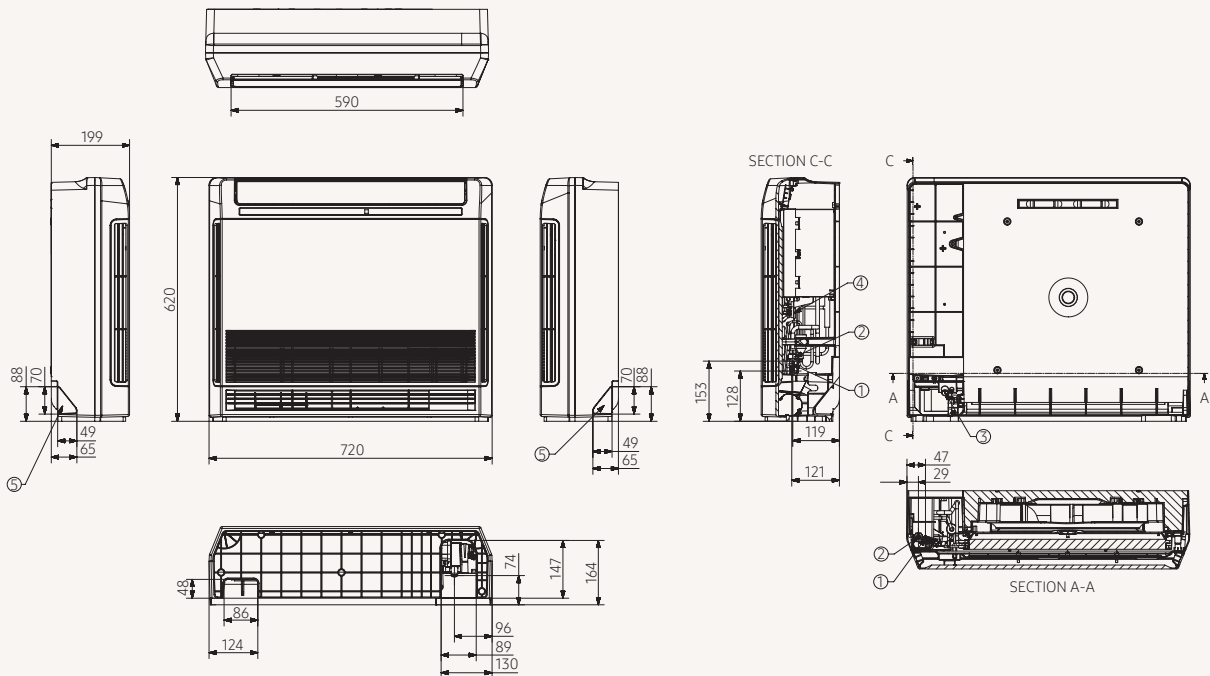

NO	Name	Description
1	Liquid pipe connection	Φ6.35(1/4)
2	Gas pipe connection	Φ12.7(1/2)
3	Drain pipe connection	ID 18mm [11/16 inch] Hose
4	Power supply & Communication wiring conduit	-
5	Knockout hole for drain hose	-

Dimensional Drawings

Wall-Mounted Hydro Unit

AE090/160MNYD*H/EU

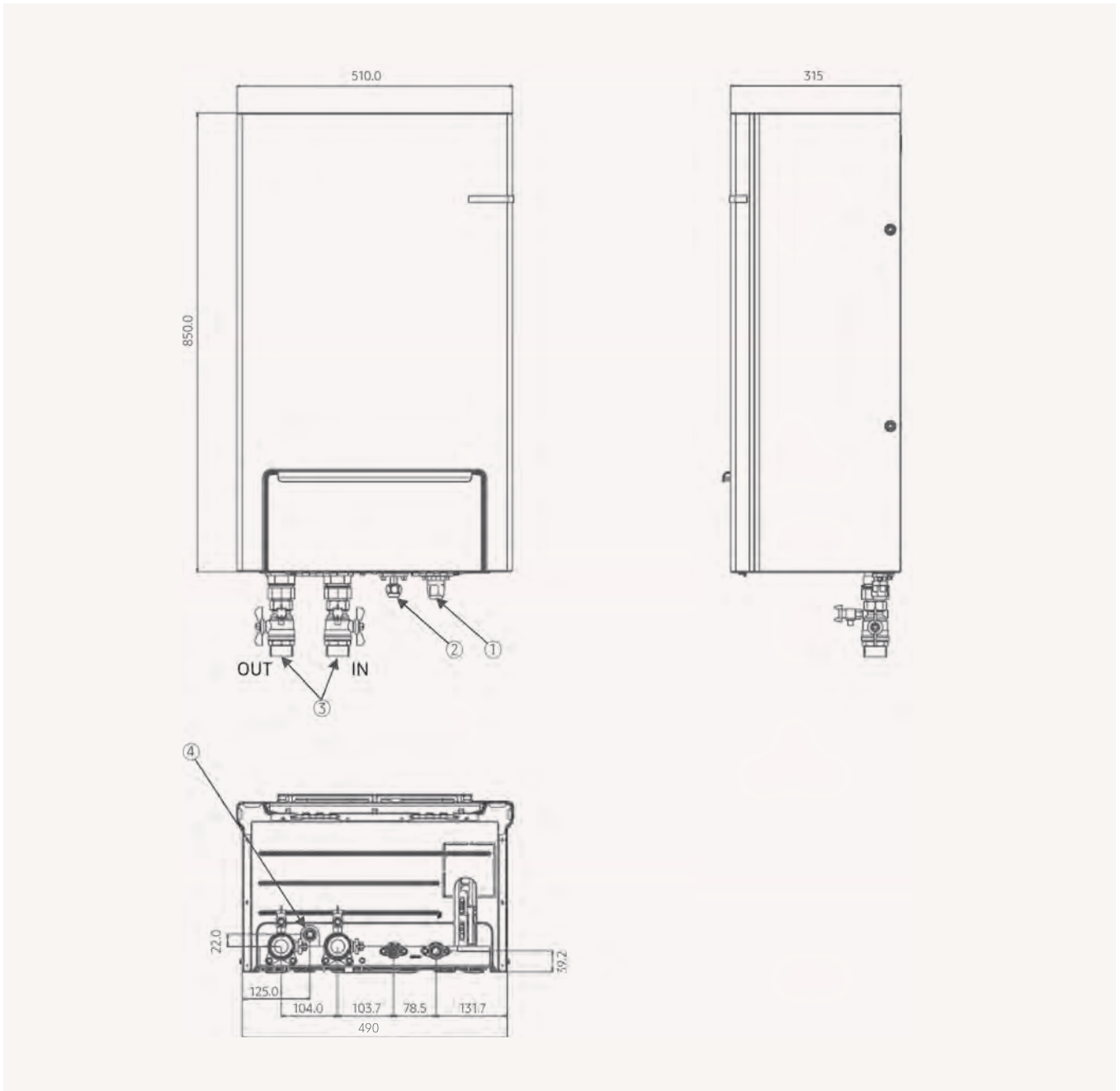

NO	Name	Description
1	Gas Ref. Pipe	ϕ 6.35 (1/4") (9kW), ϕ 9.52 (3/8) (16kW)
2	Liquid Ref. Pipe	ϕ 15.88 (5/8)
3	Water Pipe (Inlet/Outlet)	BSPP male 11/4
4	Drain Hose Connector	



Controls



Line-up





Category	Product	Model		Compatibility Table				
				EHS ClimateHub R32		EHS with Third Party Tank		
				EHS Mono R32	EHS Split R32	EHS Mono R32	EHS Split R32	EHS Split R410A
Individual Control System	Wireless Remote Controller	AR-EH03E						
		MR-EH00						
	Wired Remote Controller	MWR-WW10N		•	•	•	•	
		MWR-WW00N						•
		MWR-WE13N						
	Touch Controller	MWR-SH11N						
Mono Control Kit	MIM-E03CN				•			
Centralised Control System	Touch Controller	MCM-A300N		•	•	•	•	•
	Wi-Fi Kit 2.0	MIM-H04EN		•	•	•	•	•
Integrated Control System	DMS 2.5	MIM-D01AN		•	•	•	•	•
Interface Module & Gateway	External Contact Interface Module	MIM-B14				•	•	•
	Pulse Interface Module (PIM)	MIM-B16N		•	•	•	•	•
	Modbus Interface module	MIM-B19N		•	•	•	•	•
Others	S-Converter	MIM-C02N		•	•	•	•	•
	External room sensor	MRW-TA		•	•	•	•	•
	Receiver Kit	MRK-A10N						

Compatibility Table					
TDM Plus R410A					
TDM Plus ClimateHub R410A	Wall-Mounted Hydro Unit	TDM Plus WindFree™ Deluxe	Slim Duct	MSP Duct	Console
		•*			
			optional	optional	•*
•					
	•*				
		•	•	•	•
		•	•	•	•
•	•	•	•	•	•
•	•	•	•	•	•
•	•	•	•	•	•
	•	•	•	•	•
•	•	•	•	•	•
•	•	•	•	•	•
•	•	•	•	•	•
•	•	•	•	•	•
•	•	•	•	•	•
			•	•	

* No need to order separately, controller is already included.

Features

Controls | Individual Control

Wireless / Wired Remote Controllers		
<p>Wireless Remote Controller Standard with WindFree™</p> <p>AR-EH03E</p>		<ul style="list-style-type: none"> • WindFree™ On/Off • Filter replacement alarm reset • Simple On/Off timer • Indoor unit option code setting • Temperature setting range • Auto/Cool/Dry : 18°C - 30°C • Heat : 16°C - 30°C • Direct/Indirect function On/Off • Motion Detect Sensor necessary • Net dimensions (W x H x D): 48 x 138 x 24mm
<p>Wired Remote Controller Standard type for EHS</p> <p>MWR-WW10N</p>		<ul style="list-style-type: none"> • Full color 4.3" LCD screen • Easy and Intuitive UI • 2-zone Control • LCD Backlight • Multiple Language support* • IR receiver is included • Daylight Savings Time • °C / °F Convertible • Error list display • Built-in room temperature sensor • SD slot • Net dimensions (W x H x D): 120 x 120 x 19mm <p>* Available languages: English, German, Spanish, French, Italian and Polish.</p>
<p>Wired Remote Controller</p> <p>MWR-WE13N MWR-WW00N</p>		<ul style="list-style-type: none"> • Air conditioner/ERV operation setting (Horizontal air flow, WindFree™) • LCD Backlight • Air conditioner/ERV error monitoring • Air conditioner individual blade control • Filter cleaning alert/reset alert time • Air conditioner/ERV interlocking control • Energy saving control • Automatic operation stop function • Weekly operation schedule setting • Button restriction function • Built-in room temperature sensor • Real time clock (Daylight Savings Time) • Control max. 16 indoor units (Air conditioner + ERV) in group with single wired remote controller • Net dimensions (W x H x D): 120 x 124 x 19.5mm
<p>Wired Remote Controller Touch Simple type</p> <p>MWR-SH11N</p>		<ul style="list-style-type: none"> • Touch screen wired remote controller • LCD Backlight • IR receiver is included • Away function • Quiet mode, Sleep mode • Reset filter cleaning alert indicator • Air conditioner Individual/group control • Operation On/Off timer function • WindFree™/Long horizontal wind • Button locking function • Eliminate Operation Mode function : Auto/Cool/Dry/Fan/Heat mode • Built-in room temperature sensor • °C / °F Convertible • Relative temperature setting function : -3 ~ +3°C setting • Control max. 16 indoor units in group with a single wired remote controller • Net dimensions (W x H x D): 94.2 x 122 x 19.5mm
<p>Mono Control Kit</p> <p>MIM-E03CN</p>		<ul style="list-style-type: none"> • EHS R32 Mono control Kit • Includes remote controller (MWR-WW10N) and flow sensor • Mounting box with the control printed board assembly • Leaving and return water sensors • Domestic Hot Water sensor • Net Dimensions (WxHxD) mm 290 x 110 x 370 mm

Controls | Centralised Control

Centralised Control Systems		
<p>Touch Controller MCM-A300N</p>		<ul style="list-style-type: none"> • 7 inch touch LCD controller • Controls max. 128 indoor units • Controls max. 12 zones • Schedule control, Indoor unit usage restriction, View indoor unit error history • Net dimensions (W x H x D): 205 x 163 x 38mm
<p>Wi-Fi Kit 2.0 MIM-H04EN</p> <p> </p>		<ul style="list-style-type: none"> • Enhanced Convenience • Voice Control available through a smartphone with Bixby • Connected home with affordable units in every home using SmartThings • Welcome cooling and heating based on Geo-fencing • Individual indoor unit control • Personalized Climate Environment • Preferred automation • Multi-device experience interoperable with smart appliances • Energy Usage Monitoring • Current and daily, weekly or monthly energy usage* of the outdoor unit • Provides ease of installation • Easy set-up possible for up to 16 indoor units at once • Net dimensions (W x H x D): 185 x 130 x 29mm



Controls | Integrated Control

Integrated Control Systems		
<p>DMS2.5 MIM-D01AN</p>		<ul style="list-style-type: none"> • Built-in web server for PC-independent management and remote access control • Multiple upper-layer control access (S-NET 3, Web-client) • Weekly/Daily schedule control • Power distribution function • Current time management even during power failure (for 24 hours) • Emergency stop function with simple contact interface • Individual/Group control of up to 256 indoor units, AHU and ERV • User editable control logic • Accessible level management. • Dynamic security management • Operation & error history management • Data storage in non-volatile memory & SD memory • Net dimensions (W x H x D): 240 x 255 x 65mm



* Calculated by Samsung's own algorithm, it cannot be used as a legal basis.

Features

Controls | Interface devices

Module, Application Kit, Gateway		
<p>External Contact Interface Module</p> <p>MIM-B14</p>		<p>The Samsung Guestroom Management System saves users the energy and money wasted on cooling an unoccupied room. The air conditioner is activated when the Key-Tag is in place and turns off when the Key-Tag is removed.</p> <p>An external contact interface module provides direct indoor unit control via an external contact signal, as well as window-synchronised indoor unit control. The emergency control function features simple contact input. Plus the module generates indoor unit operation/error state output through relay contacts.</p> <ul style="list-style-type: none"> • Direct indoor unit control by external contact signal • Window-synchronised indoor unit control • Emergency control with simple contact input • Indoor unit operation/error state output through relay contacts • Net dimensions (W x H x D): 50 x 80 x 35mm
<p>Modbus Interface Module</p> <p>MIM-B19N</p>		<p>A BMS or 3rd controller can control a Samsung SAC by using the Modbus protocol.</p> <ul style="list-style-type: none"> • BMS unit protocol: Modbus RS485 (2 wires, max. 1,000m) • Unit connection protocol: Samsung Control Layer Protocol (R1/R2) • Max. No. of connection units: 1 outdoor unit (4 outdoor units including sub units in the case of modular installation) and 48 indoor units • Modbus interface module address range : up to 247 • Net dimensions (W x H): 50 x 80mm
<p>Pulse Interface Module (PIM)</p> <p>MIM-B16N</p>		<p>The Watt-hour Meter Interface Module can be exclusively used for DMS 2.5 power distribution, displaying power consumption for each watt-hour meter.</p> <ul style="list-style-type: none"> • Exclusive use for DMS 2.5 power distribution • Connection with up to 8 watt-hour meters • Pulse interface with watt-hour meters • Watt-hour meter - by 3rd party • Net dimensions (W x H x D): 240 x 255 x 65mm

Controls | Others





Module, Application Kit, Gateway		
S-Converter		<p>Communication converting module to connect a Samsung system air conditioner to a PC</p> <ul style="list-style-type: none"> • Main reasons for use: <ul style="list-style-type: none"> - To connect with test run program [Test run program] - S-NET Pro: Conventional communication - S-NET Pro2: New communication • Net dimensions (W x H x D): 66 x 92 x 28mm
External Room Sensor		<ul style="list-style-type: none"> • Indoor unit is operated by MRW-TA instead of its own sensor. • Wire length: 12 m (39 ft)
Receiver Kit		<ul style="list-style-type: none"> • Concealed wireless signal receiver • Filter replacement sign • Fan operation display • Operation Timer setting display • Operation On/Off button • Operation On display LED (blue) • Defrost operation display LED (red) • Net dimensions (W x H x D): 80 x 130 x 28mm





Accessories

Compatibility

Accessories		Name	Indoor unit	TDM Plus Slim Duct	TDM Plus MSP Duct	TDM Plus WindFree™ Deluxe	TDM Plus Console	Wall-Mounted Hydro Unit	EHS ClimateHub
		Name	Model code	2.2-5.6 kW	7.1-9.0 kW	2.2- 7.1 kW	2.2-5.6 kW	9.0/16.0 kW	200/260 L
EEV Kit (1/2/3 room)		1 Indoor	MEV-E24SA			•			
			MEV-E32SA			•			
		2 Indoor	MXD-E24K132A			•			
	MXD-E24K200A				•				
	MXD-E32K200A				•				
	3 Indoor	MXD-E24K232A			•				
		MXD-E24K300A			•				
		MXD-E32K224A			•				
			MXD-E32K300A			•			
Y-Joint		(≤15.0 kW and below)	MXJ-YA1509M	•	•	•	•	•	
							(TDM Plus only)	(TDM Plus only)	
Drain Pump		Internal	MDP-E075SEE3D	•					
		External	MDP-G075SP		•				
		Internal	MDP-G075SQ		•				
Backup Heater		4 kW	MHC-400FE						•
		6 kW	MHC-600FE						•



Design and Support





SAMSUNG

HOME TECH RESOURCES

LOGIN REGISTER

Welcome to the Samsung Partner Portal

A built for all things Samsung, dedicated to our Complex Solutions Partners.

REGISTER

Welcome to the Samsung Partner Portal

As a Samsung Solutions partner, you will have access to our partner portal. Our resources include training, marketing, and more. You need to consistently deliver the best results.

Samsung Climate Solutions Partner Portal

As one of Samsung's registered Climate Solutions partners, you will have access to our Partner Portal and its many benefits. Whether you are looking for marketing materials or technical product documentation, requesting technical support or registering for training, the Samsung Climate Solutions Partner Portal offers you everything you need to consistently deliver the best results.

Access technical resources

The Technical Resources section provides you with all of the relevant information you need to understand the product's functionality and to prepare and design projects. A library full of technical information is at your fingertips, ranging from technical data books, BIM files and certificates to exploded views, drawings and different kinds of manuals.

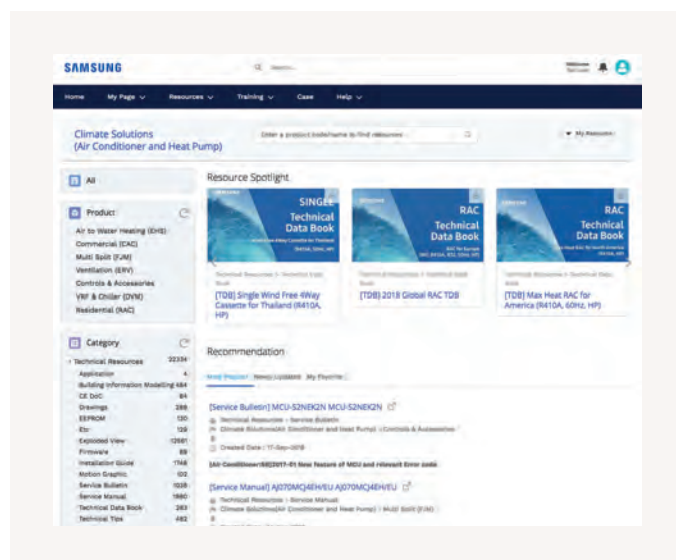

Obtain marketing resources

Potential buyers like to know that you are on the cutting edge of Samsung's latest innovations. To enable you to align with Samsung's marketing initiatives, the Partner Portal provides you with useful downloadable assets such as images and videos, designed to make your marketing activities easy and effective.

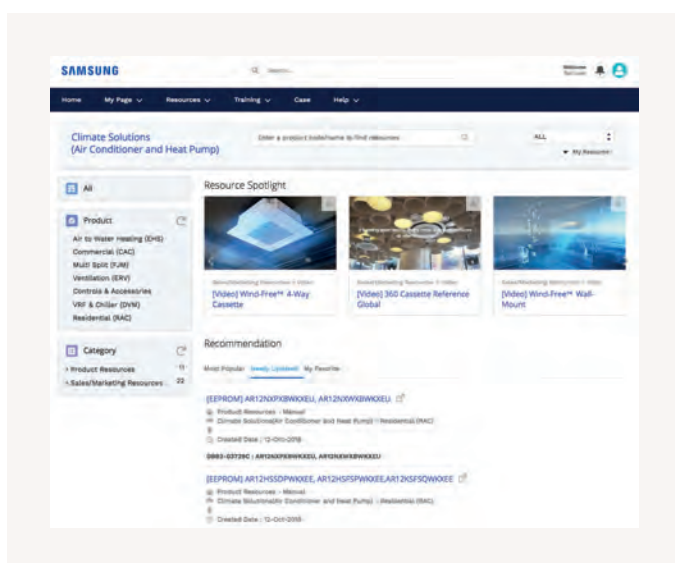

Request technical support

You can easily request technical support through the Samsung Partner Portal by reporting your case using our built-in ticketing system. You can rest assured that our well-trained technical experts will work to solve your issue as soon as possible.

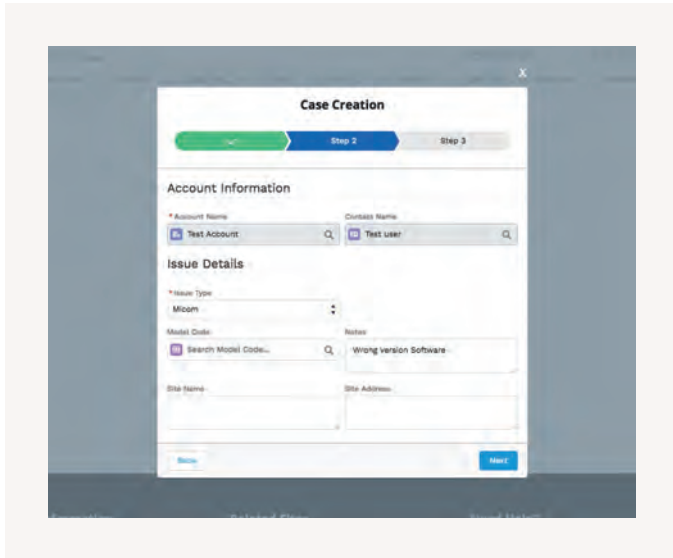

Register for training

If you are dedicated to becoming a Samsung climate solutions expert, you can access Samsung's educational portal for training sessions provided by experienced trainers. The portal allows you to search for online courses and materials, test your climate solutions knowledge, and more. The Samsung Business Academy is here to help you succeed.¹

¹ The registration process for and availability of training courses may vary per country. Please contact your direct Samsung contact person for more information.

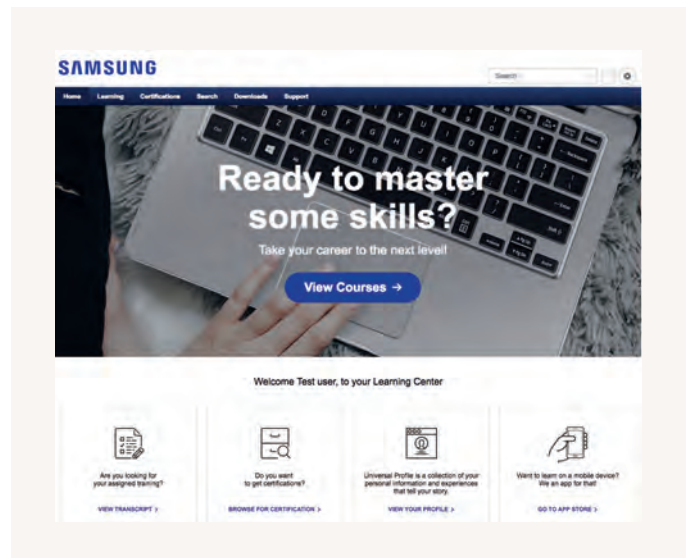

How to access



Register

To register for the Samsung Climate Solutions Partner Portal, open your web browser¹ and go to partnerhub.samsung.com/climate to complete the registration form.



Access

Your information will be verified and your account will be activated. You will receive your personal login details.



Manage account

Keep your account details up to date and invite your colleagues to join.



Search and download

Access a full library of resources, request technical support, or sign up for a Climate Solutions Academy training session.

¹ Google Chrome is the recommended web browser for using the Samsung Climate Solutions Partner Portal.



DVM Pro 2.0



SAMSUNG

Samsung DVM Pro 2.0 NEW

Samsung introduces new updated version of DVM Pro version 2.0. Product selection is extended and now the tool is also available for EHS and HVM lineup.

Samsung DVM Pro 2.0 is an advanced design automation programme which helps you to select the most suitable equipment for easily and precisely designing your air conditioning system. It helps to ensure that the system's design falls within Samsung's engineering guidelines. With its reports, pipe and wire diagrams, additional refrigerant values and other information, Samsung DVM Pro 2.0 is a powerful tool for engineers, designers or installers.

Sales Mode

Sales Mode enables users to define their requirements and select air conditioning products quickly and easily.

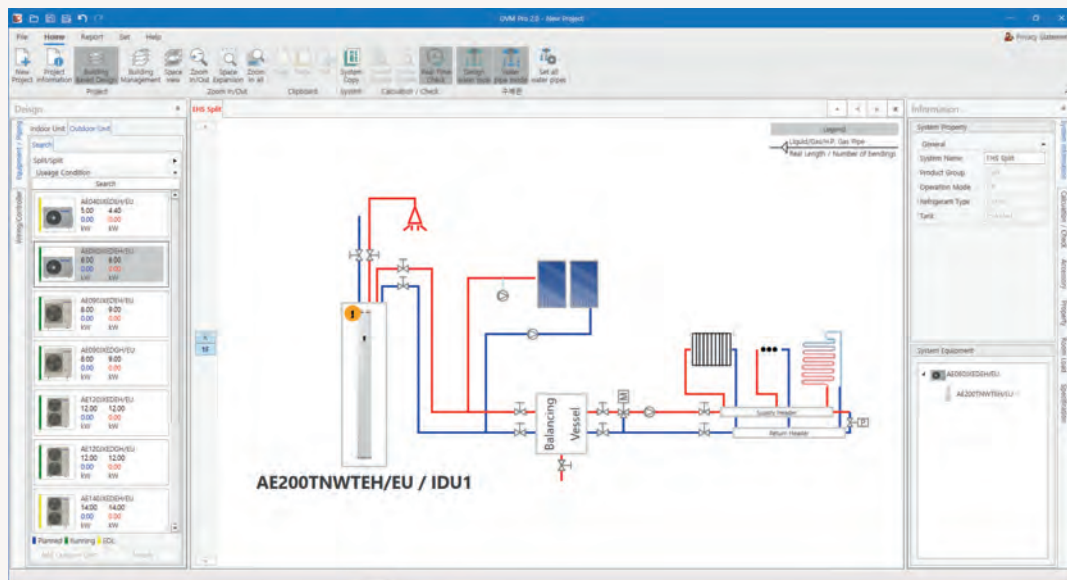

Product selection

List of equipment, including indoor units, outdoor units, controls and accessories

Reports

Specifications, diagrams in DWG & BMP format, quotations

Updated Toolbar NEW

User-friendly tool bar helps to guide intuitively

Piping schematics

Basic or manual selection with system check and capacity simulation

Control systems

Automatic control unit selection

Wiring schematics

Automatic diagrams including communication wiring for indoor/outdoor control units and electric power meters

CAD Mode

CAD Mode is an in-depth and precise design tool that enables users to design their air conditioning systems using AutoCAD software¹.

¹ Sourced separately.

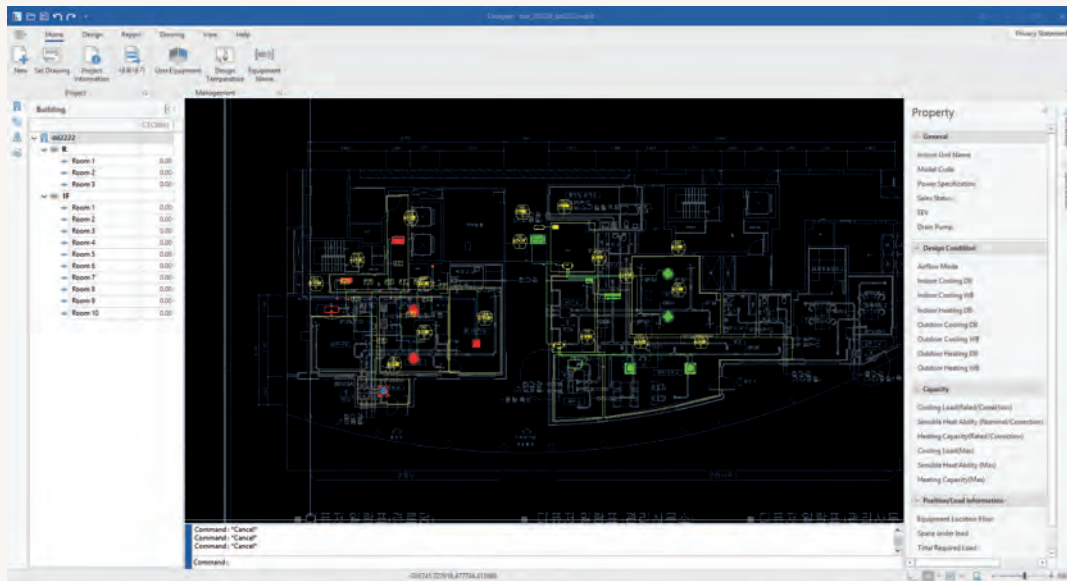

Pipe sizing & lengths
Refrigerant & drain pipe sizing

Automatic selection
Refnet joint, header & distributor kit

Automatic report
Piping installation

System check
Installation regulation & refrigerant charging

Performance simulation
Capacity correction tool against specific design conditions

Design without AutoCAD NEW
Compatible with AutoCAD and AutoCAD LT for DWG.

How to access



Register

Go to dvmpo.mkt.samsung.com to access the Samsung DVM Pro 2.0 Portal¹. If you do not have access yet, complete the registration process and you will be sent the access details.



Select

Click on DVM Pro 2.0 via the main menu and scroll to the end of the page to select the option DVM Pro 2.0 download.



Download

Download the DVM Pro 2.0 installation file, view the user manuals, and start designing your project.

¹ Google Chrome is the recommended web browser for using the Samsung DVM Pro 2.0 Portal.



Samsung Climate Solutions Academy



Samsung Climate Solutions Academy

Samsung Climate Solutions Academy is committed to providing engineers with the technical skills required to install a Samsung product efficiently, and to help relay necessary information to users. All courses are designed to provide attendees with the opportunity to develop both theoretical and practical knowledge of Samsung's vast range of equipment and solutions.



Available training modules

Essential courses: Basic commercial training

- The product line-up, accessories and available controls
- The unique features of Samsung products
- Installation considerations

Advanced courses: Technical training

- How to correctly install and configure a system
- Commissioning: common issues during commissioning and how to resolve any challenges
- Troubleshooting and fault-finding (by use of E-codes)
- Control logic
- Case studies

Advanced courses: Design training

- Understanding customers' needs and offering possible solutions
- DVM Pro 2.0 - Samsung's advanced design tool
- Case studies

Note: the registration process for and availability of training courses may vary per country. Please contact your Samsung representative for more information.

Samsung training centres in Europe



How to register for training



Search

To check for available training courses, go to Samsung Business Academy (SBA) via the Samsung Climate Solutions Partner Portal¹: partnerhub.samsung.com/climate. Search the online event calendar and select the training course you would like to attend.



Register

After identifying the training course you would like to attend, follow the registration process. Once you have registered successfully you will receive a confirmation e-mail.



Get certified

Following confirmation of your registration, we will invite you to one of our training centres. You will be trained by one of our specialised Master Trainers or Product Specialists, and receive a Certificate of Completion.

¹ Google Chrome is the recommended web browser for using the Samsung Climate Solutions Partner Portal.

Hydraulic Schematics



ClimateHub Split

Application examples

Application 1: Space heating + water heating

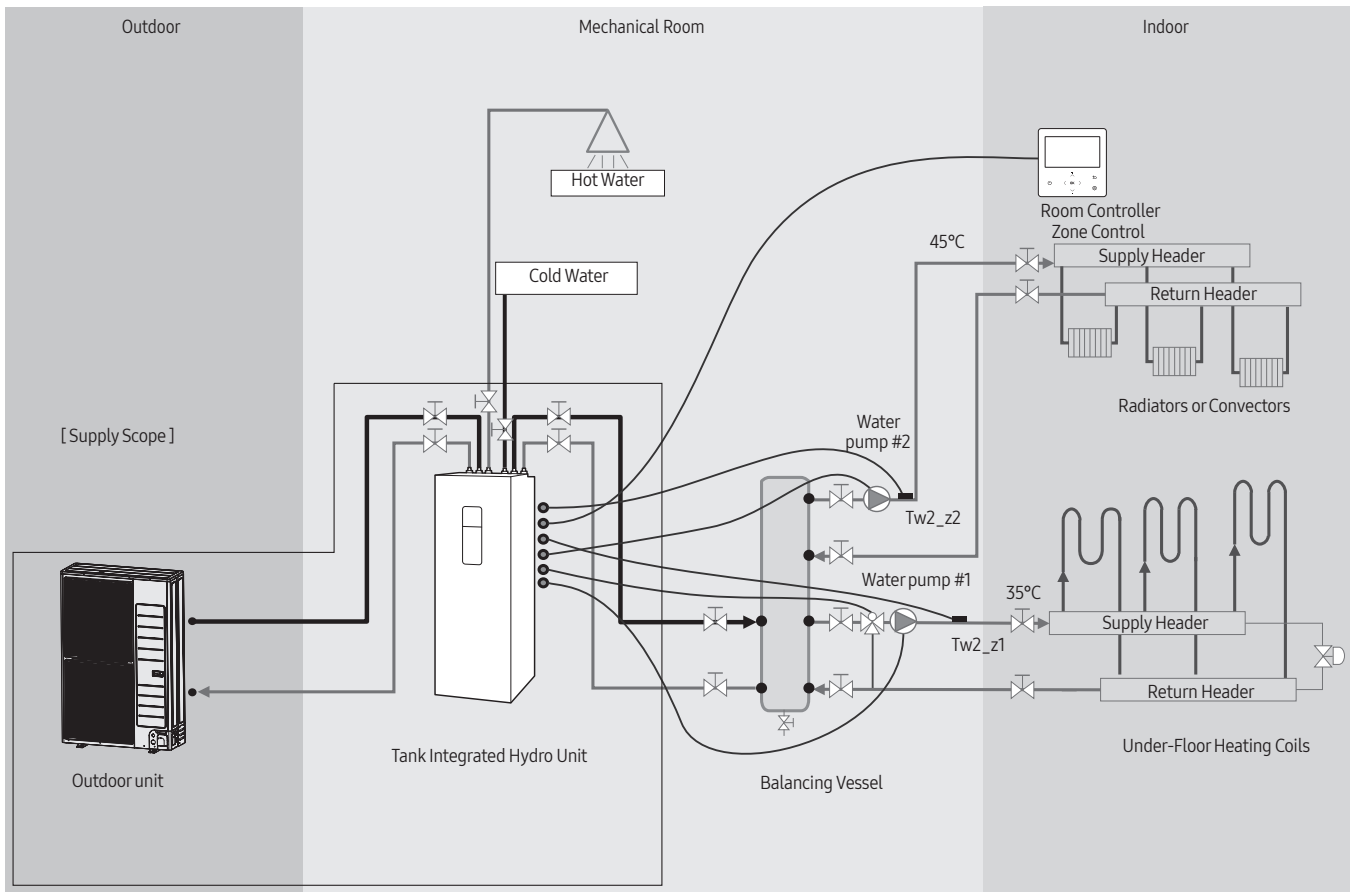

ClimateHub Split

Application examples

Application 2: Hybrid application (backup boiler and solar panel connected)

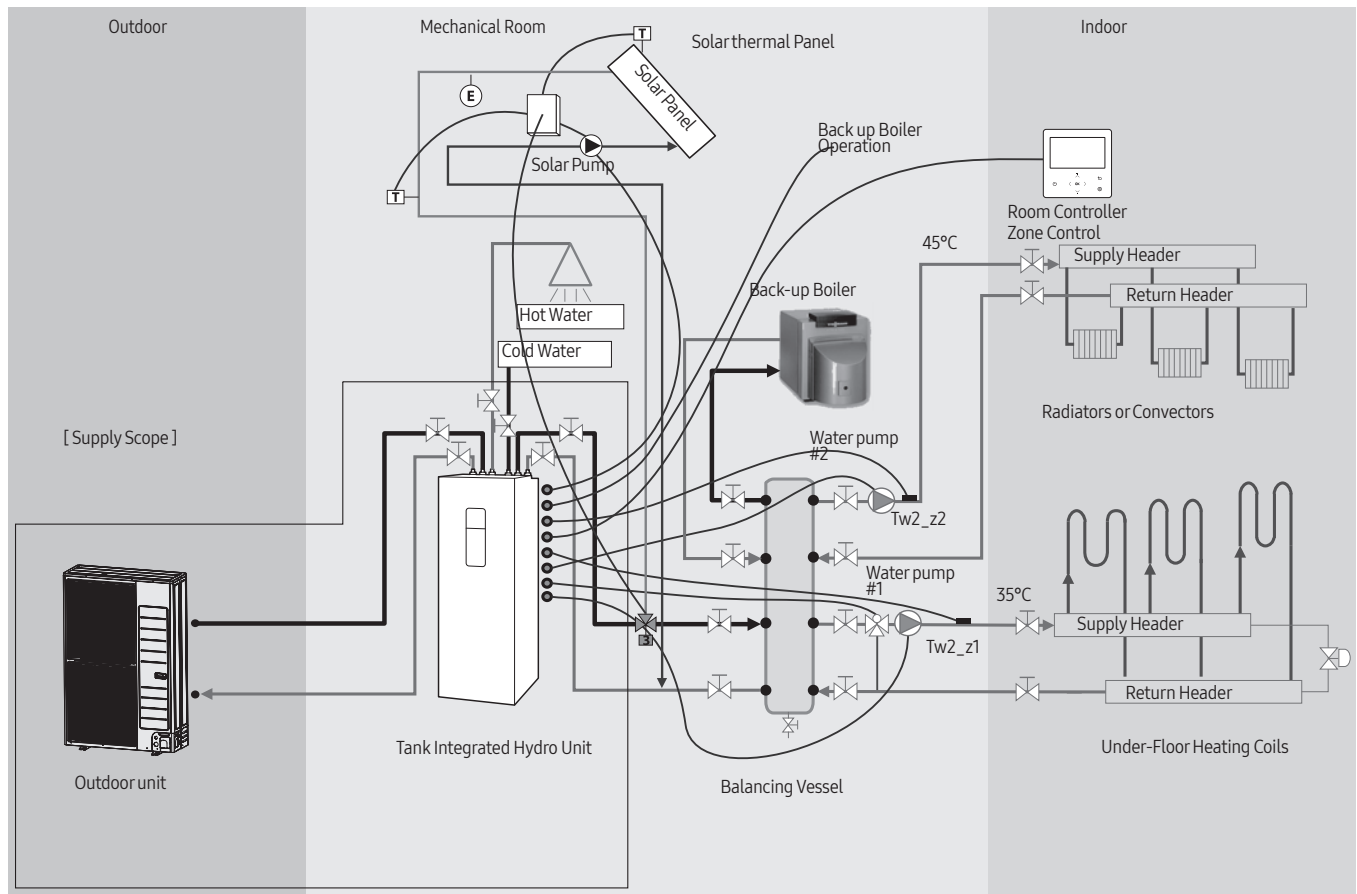

ClimateHub Mono

Application examples

Application 3: Space heating + water heating

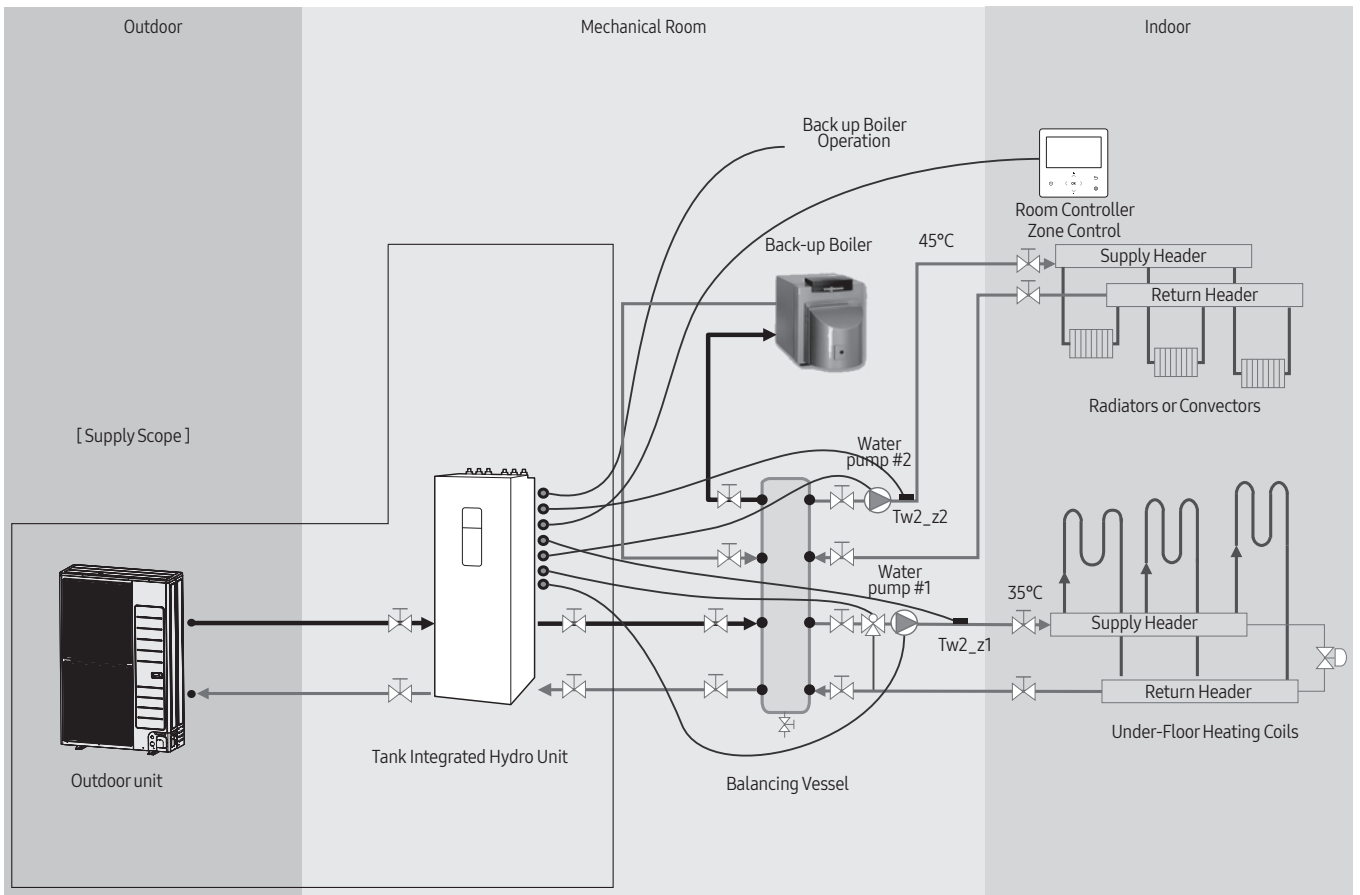

ClimateHub TDM Plus

Application examples

Application 4: Space heating + water heating/ A2A cooling

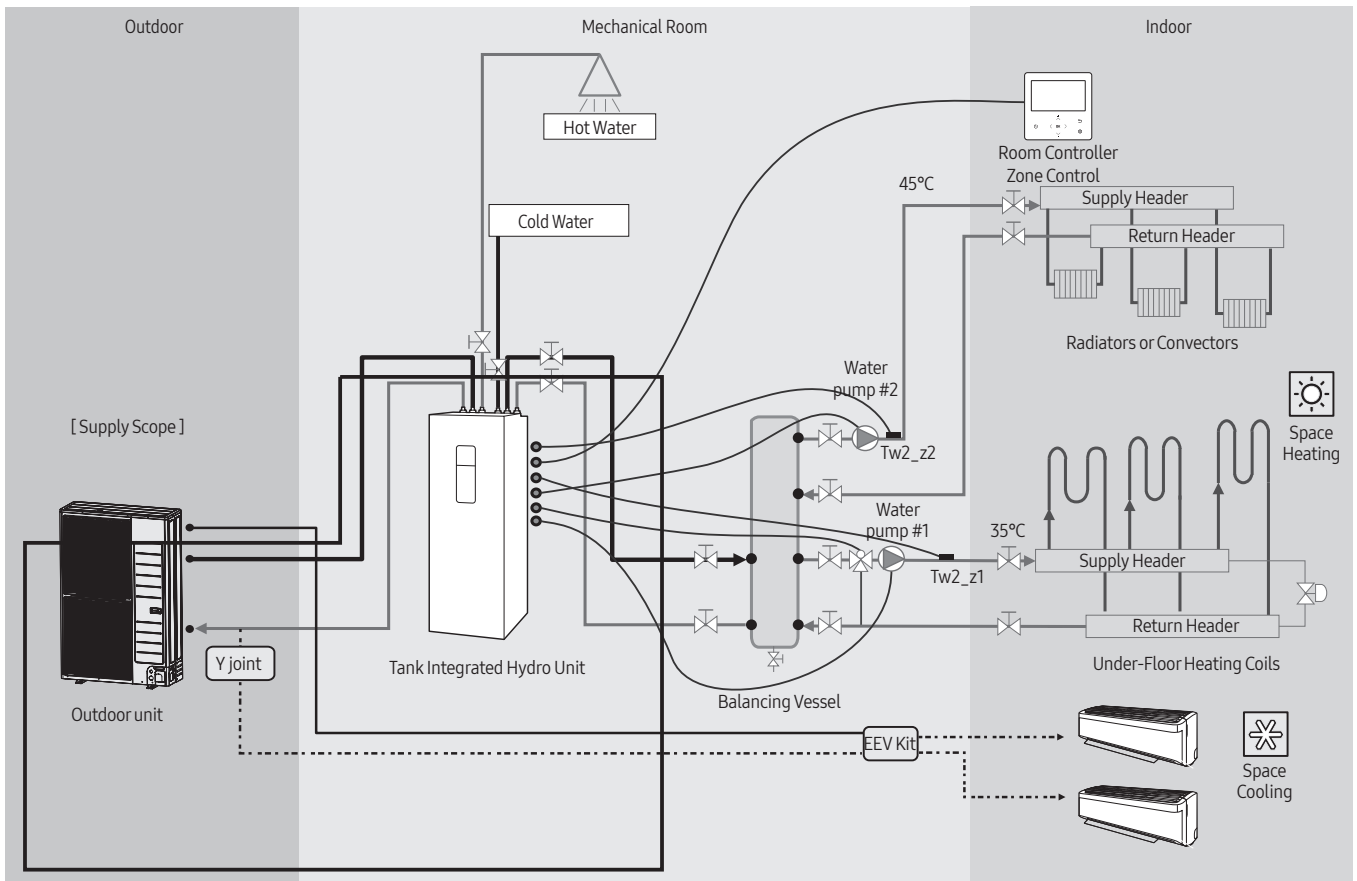

Notes

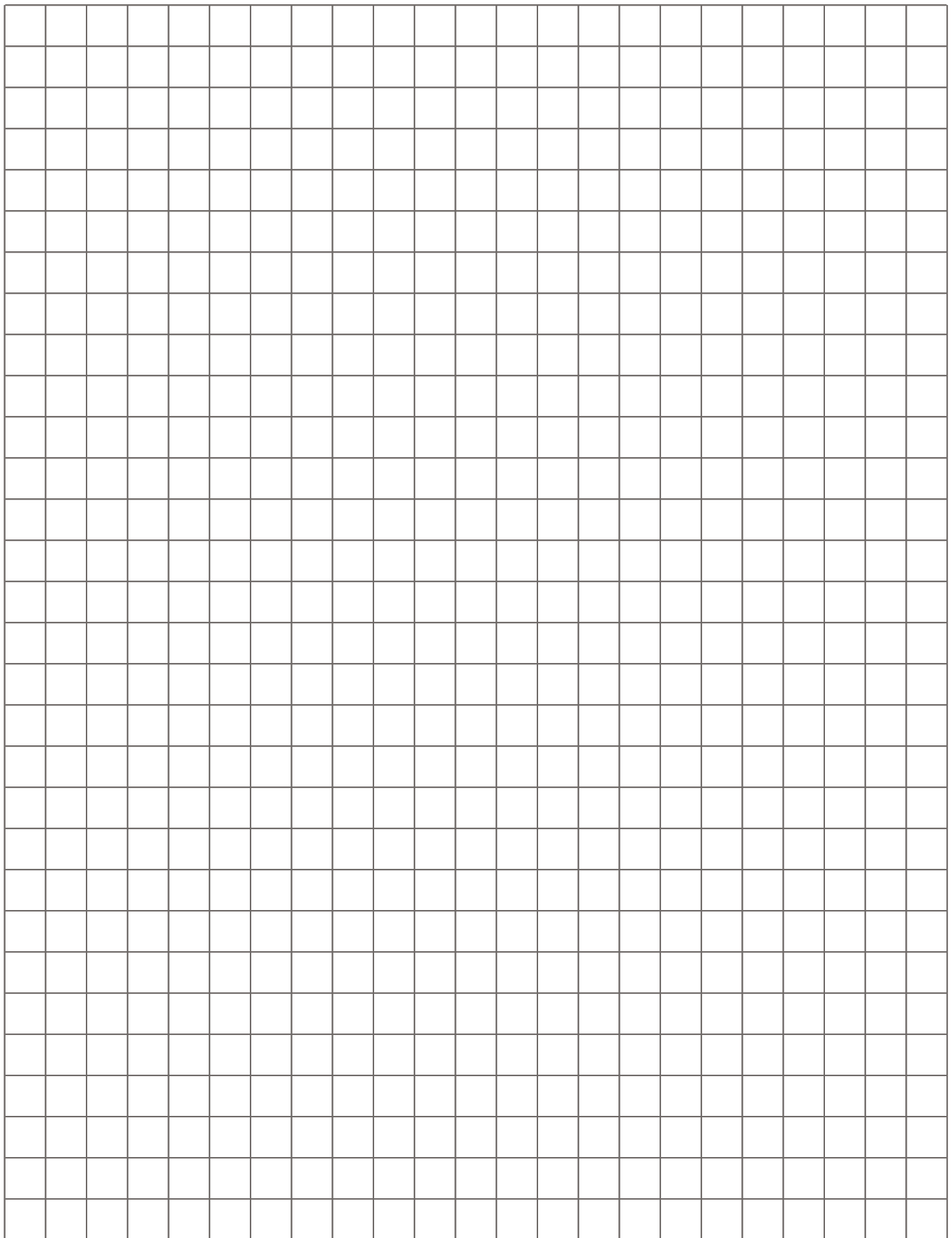

Notes

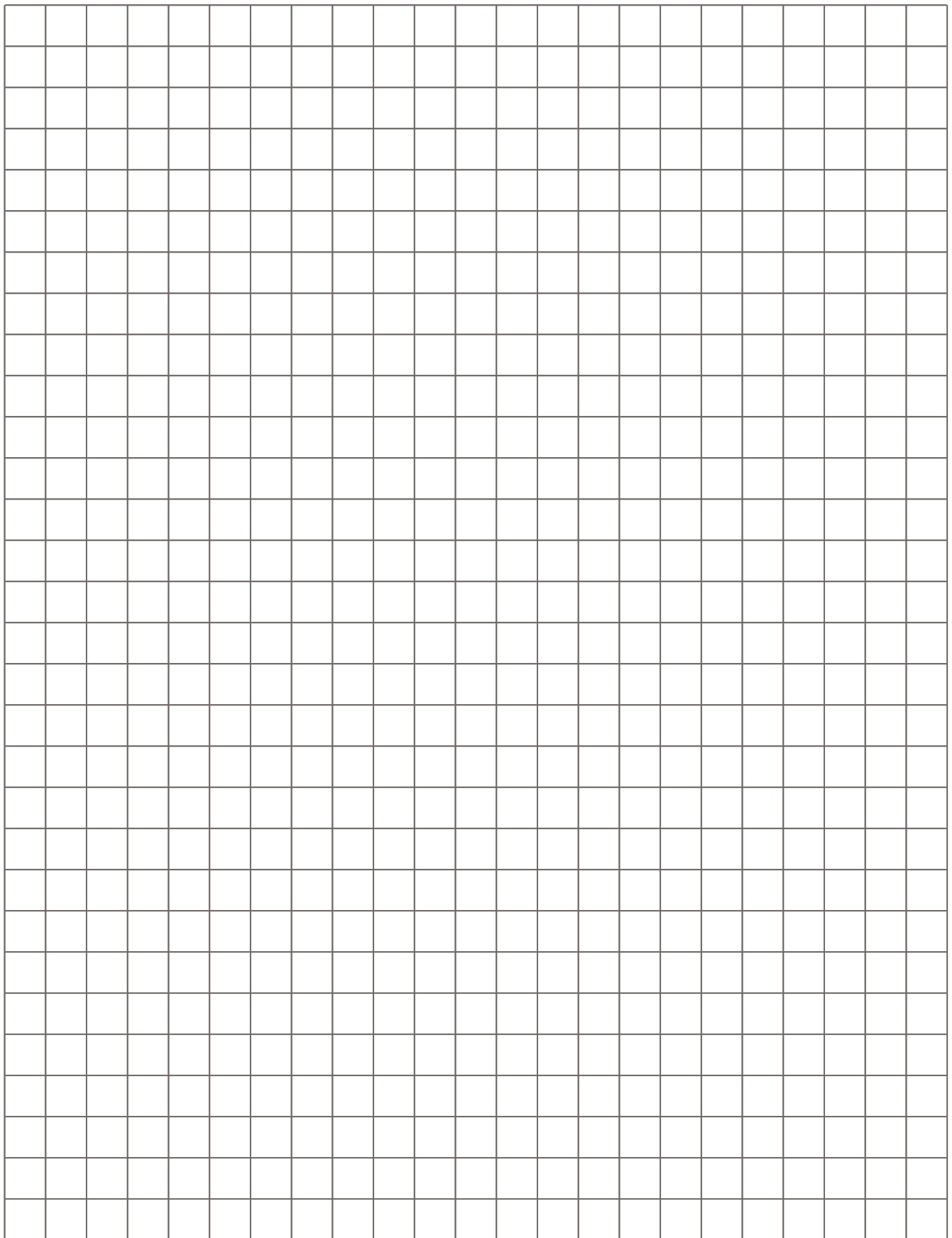

Notes

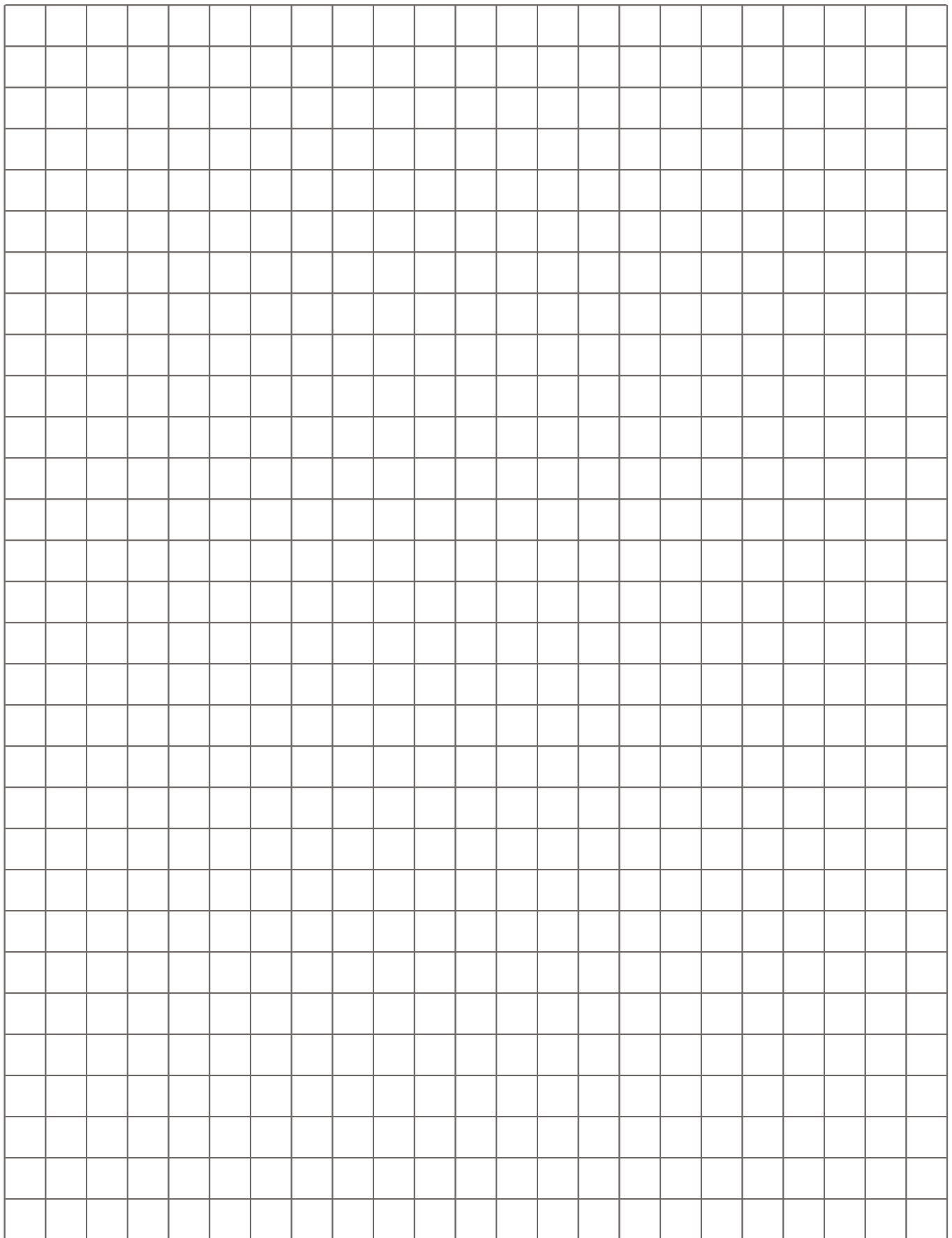

Notes

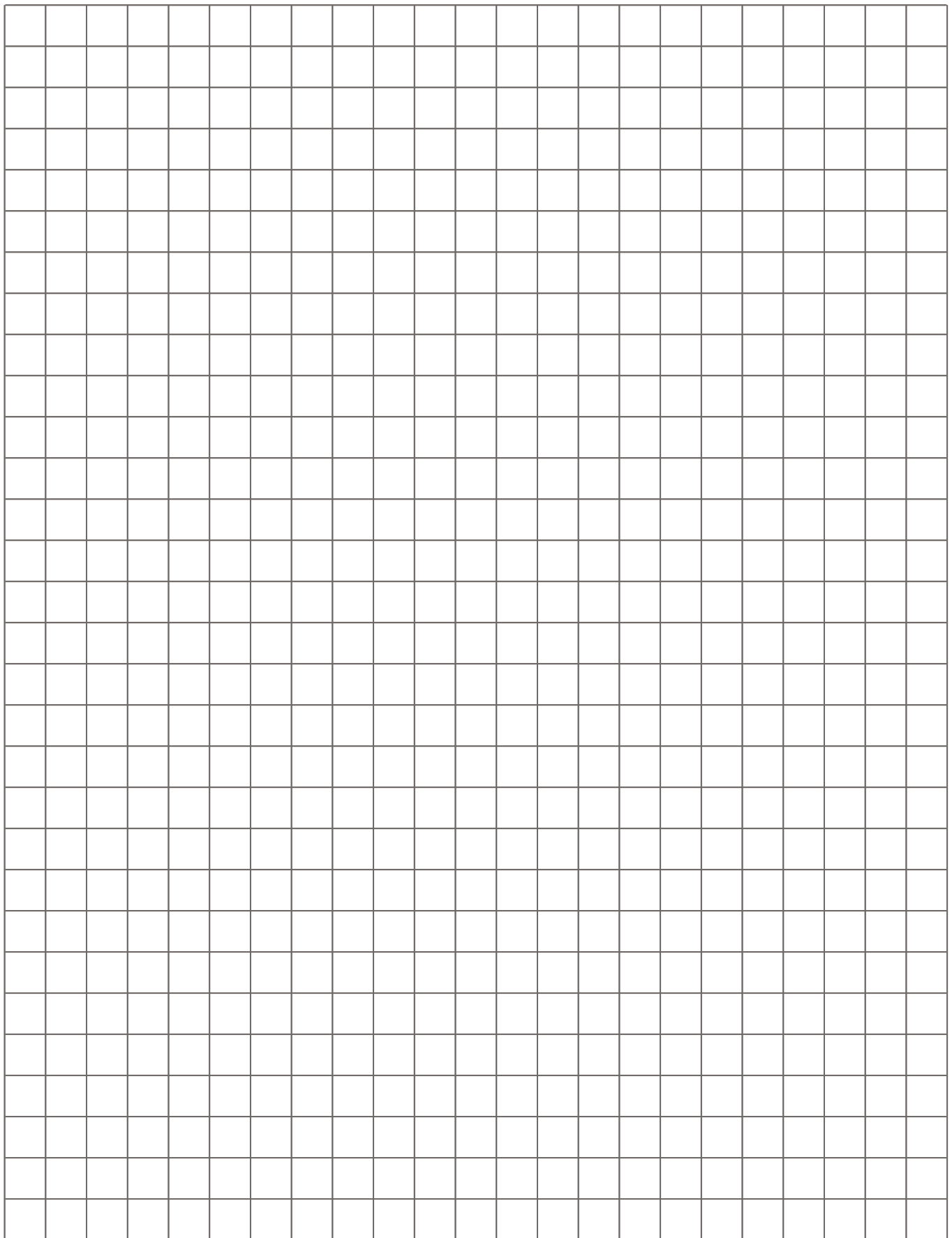

Notes

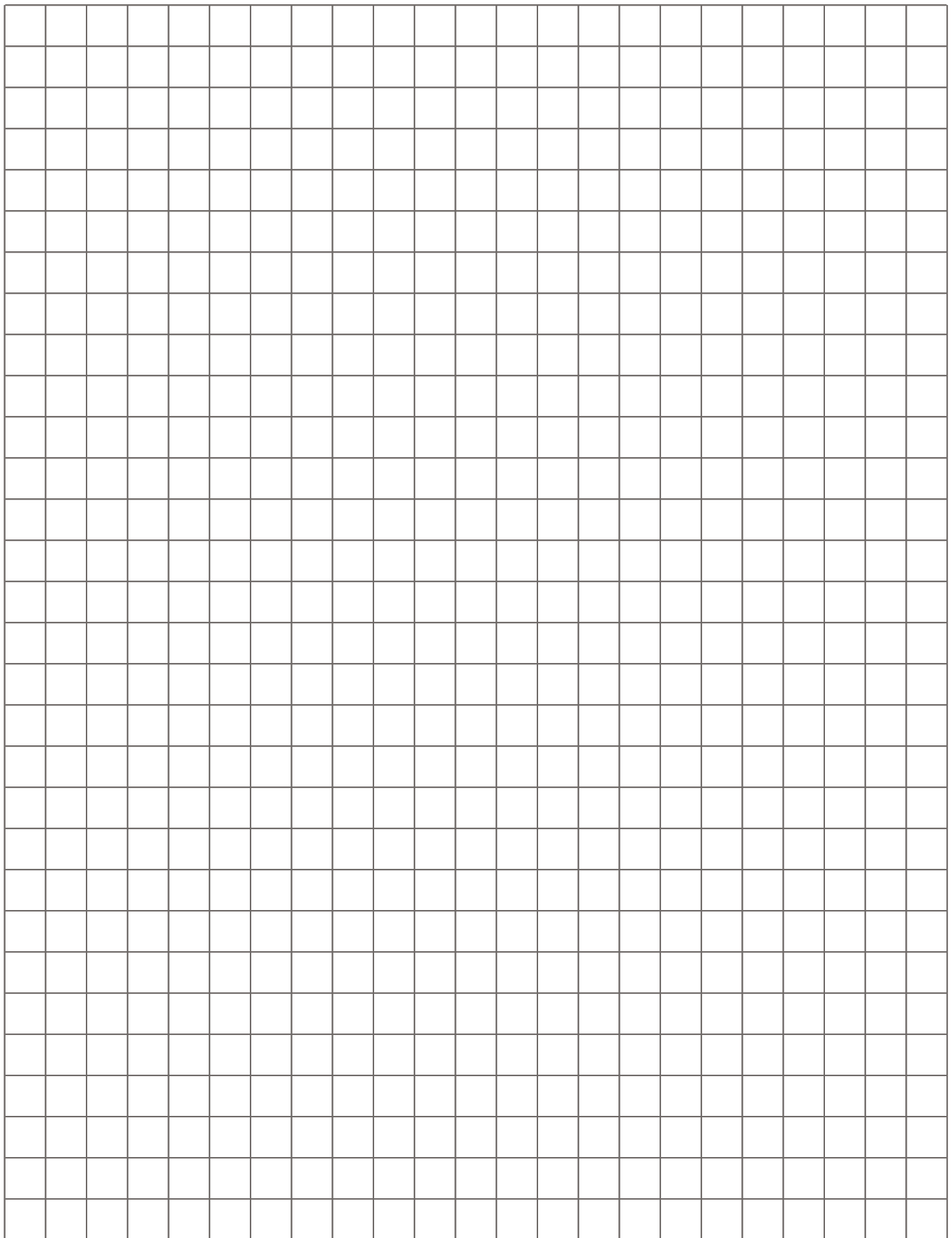

Learn more about Samsung Climate Solutions at:
www.samsung.com/climate

Copyright © 2020 Samsung Electronics Air Conditioner Europe B.V. All rights reserved. Samsung is a registered trademark of Samsung Electronics Co., Ltd. Specifications and designs are subject to change without notice and may include preliminary information. Non-metric weights and measurements are approximate. All data was deemed correct at the time of creation. Samsung is not liable for errors or omissions. Some images may be digitally altered. All brand, product, service names and logos are trademarks and/or registered trademarks of their respective owners and are hereby recognised and acknowledged.



Samsung Electronics Co., Ltd. participates in the Eurovent Certification Programme (ECP) for Air Conditioners (AC), Variable Refrigerant Flow (VRF) and Liquid Chilling Packages Heat Pump (LCP-HP). To check the ongoing validity of certification, please visit: www.eurovent-certification.com

Samsung Electronics Air Conditioner Europe B.V.
Evert van de Beekstraat 310, 1118 CX Schiphol
P.O. Box 75810, 1118 ZZ Schiphol
+31 (0)8 81 41 61 00
The Netherlands

SAMSUNG